



# 12Gb/s MegaRAID<sup>®</sup> SAS RAID Controllers

User Guide

Version 1.7

October 31, 2017

pub-005183

For a comprehensive list of changes to this document, see the [Revision History](#).

**Corporate Headquarters**

San Jose, CA

**Website**

[www.broadcom.com](http://www.broadcom.com)

Broadcom, the pulse logo, Connecting everything, Avago Technologies, Avago, the A logo, MegaRAID, CacheCade, Fusion-MPT, and SafeStore are among the trademarks of Broadcom and/or its affiliates in the United States, certain other countries and/or the EU.

Data subject to change. Copyright © 2013–2017 by Broadcom. All Rights Reserved.

The term "Broadcom" refers to Broadcom Limited and/or its subsidiaries. For more information, please visit [www.broadcom.com](http://www.broadcom.com)

Broadcom reserves the right to make changes without further notice to any products or data herein to improve reliability, function, or design.

Information furnished by Broadcom is believed to be accurate and reliable. However, Broadcom does not assume any liability arising out of the application or use of this information, nor the application or use of any product or circuit described herein, neither does it convey any license under its patent rights nor the rights of others.

---

# Table of Contents

<b>Chapter 1: Overview</b>	<b>5</b>
1.1 Overview	5
1.1.1 SAS/SATA Standards and Communication Protocols	5
1.1.2 Cache Backup Support Using CacheVault Flash Modules and CacheVault Power Modules	6
1.2 General Description	6
1.3 12Gb/s MegaRAID SATA+SAS RAID Controllers – Detailed Descriptions	7
1.3.1 MegaRAID SAS 9341-4i RAID Controller	7
1.3.2 MegaRAID SAS 9341-8i RAID Controller	7
1.3.3 MegaRAID SAS 9361-4i RAID Controller	7
1.3.4 MegaRAID SAS 9361-8i RAID Controller	8
1.3.5 MegaRAID SAS 9361-16i RAID Controller	8
1.3.6 MegaRAID SAS 9361-24i RAID Controller	8
1.3.7 MegaRAID SAS 9380-4i4e RAID Controller	8
1.3.8 MegaRAID SAS 9380-8e RAID Controller	8
1.3.9 MegaRAID SAS 9380-8i8e RAID Controller	8
1.3.10 MegaRAID SAS 9365-28i RAID Controller	8
1.4 Configuration Scenarios	8
1.5 SAS Benefits	9
1.5.1 PCI Express Architecture	10
1.5.2 Operating System Support	10
1.6 Summary of 12Gb/s MegaRAID SATA+SAS RAID Controller Characteristics	10
1.6.1 SAS Features	11
1.6.2 SAS Array Limitations	12
1.6.3 SATA III Features	12
1.6.4 PCIe Performance	13
1.6.5 Usability Features	13
1.6.6 Flexibility Features	13
1.6.7 Drive Roaming	14
1.6.8 Drive Migration	14
1.7 Hardware Specifications	15
1.8 Technical Support	16
<b>Chapter 2: MegaRAID SAS Hardware Installation</b>	<b>17</b>
2.1 Requirements	17
2.2 Quick Installation	17
2.3 Detailed Installation	18
2.4 After Installing the RAID Controller	20
2.5 SAS Device Cables and Connectors	20
2.5.1 Connecting a RAID Controller with Internal Port Connectors to Internal Drives	21
2.5.2 Connecting MegaRAID 16-Phy Controllers with Port Widths Greater than x1	22
2.5.3 Connecting a RAID Controller with External Port Connectors to a Drive Enclosure	23
<b>Chapter 3: 12Gb/s MegaRAID SAS RAID Controller Characteristics</b>	<b>24</b>
3.1 MegaRAID SAS 9341 RAID Controllers	24
3.1.1 MegaRAID SAS 9341 RAID Controllers – Board Layout, Jumper, and Connector Information	24
3.2 MegaRAID SAS 9361 RAID Controllers	25
3.2.1 MegaRAID SAS 9361-8i and MegaRAID SAS 9361-4i RAID Controller – Board Layout, Jumper, and Connector Information	25
3.2.2 MegaRAID SAS 9361-16i RAID Controller – Board Layout, Jumper, and Connector Information	28
3.2.3 MegaRAID SAS 9361-24i RAID Controller – Board Layout, Jumper, and Connector Information	30
3.3 MegaRAID SAS 9380 RAID Controllers	31
3.3.1 MegaRAID SAS 9380-4i4e RAID Controller – Board Layout, Jumper, and Connector Information	31
3.3.2 MegaRAID SAS 9380-8e RAID Controller – Board Layout, Jumper, and Connector Information	34
3.3.3 MegaRAID SAS 9380-8i8e RAID Controller – Board Layout, Jumper, and Connector Information	36
3.4 MegaRAID SAS 9365-28i RAID Controller	37

---

3.4.1 MegaRAID 9365-28i RAID Controller – Board Layout, Jumper, and Connector Information .....	38
3.5 Technical Specifications .....	39
3.5.1 RAID Controller Specifications .....	39
3.6 Array Performance Features .....	40
3.7 Fault Tolerance Features .....	41
3.8 Electrical Characteristics .....	41
3.8.1 Operating and Nonoperating Conditions .....	41
3.8.2 MegaRAID SAS 9341-4i RAID Controller and MegaRAID SAS 9341-8i RAID Controller Power Supply Requirements .....	42
3.8.3 MegaRAID SAS 9361-4i RAID Controller and MegaRAID SAS 9361-8i RAID Controller Power Supply Requirements .....	42
3.8.4 MegaRAID SAS 9361-16i RAID Controller Power Supply Requirements .....	43
3.8.5 MegaRAID SAS 9361-24i RAID Controller Power Supply Requirements .....	43
3.8.6 MegaRAID SAS 9380-4i4e RAID Controller Power Supply Requirements .....	44
3.8.7 MegaRAID SAS 9380-8e RAID Controller Power Supply Requirements .....	44
3.8.8 MegaRAID SAS 9380-8i8e RAID Controller Power Supply Requirements .....	44
3.8.9 MegaRAID 9365-28i SAS RAID Controller Power Supply Requirements .....	45
3.9 Safety Characteristics .....	45
3.10 Accessory Instructions .....	45
<b>Appendix A: Glossary .....</b>	<b>46</b>
<b>Revision History .....</b>	<b>50</b>
Version 1.7, October 31, 2017 .....	50
Version 1.6, October 20, 2017 .....	50
Version 1.5, June 14, 2017 .....	50
Version 1.4, May 18, 2017 .....	50
Version 1.3, May 11, 2016 .....	50
54027-00, Rev. C, February 2015 .....	51
54027-00, Rev. B, April 2014 .....	51
54027-00, Rev. A, October 2013 .....	51

# Chapter 1: Overview

This document is the primary reference and user guide for the Broadcom MegaRAID<sup>®</sup> SATA+SAS RAID controllers based on the 12Gb/s SAS/SATA RAID-on-a-chip (RoC) devices. This document contains complete installation instructions and specifications for these RAID controllers.

## 1.1 Overview

The 12Gb/s MegaRAID SATA+SAS RAID controllers are high-performance intelligent PCIe-to-SATA+SAS controllers with RAID control capability. The 12Gb/s MegaRAID SATA+SAS RAID controllers provide reliability, high-performance, and fault-tolerant drive subsystem management. They are an ideal RAID solution for the internal storage of workgroup, departmental, and enterprise systems. The 12Gb/s MegaRAID SATA+SAS RAID controllers offer a cost-effective way to implement RAID in a server. In addition, most 12Gb/s MegaRAID RAID controllers support CacheVault technology, which protects cache data if the host system loses power or a server failure occurs.

SAS technology brings a wealth of options and flexibility with the use of SAS devices and SATA devices within the same storage infrastructure. However, SAS devices and SATA devices bring individual characteristics that make each one a more suitable choice depending on your storage needs. MegaRAID technology gives you the flexibility to combine these two similar technologies on the same controller, within the same enclosure, and in the same virtual drive.

**NOTE** Carefully assess any decision to mix SAS drives and SATA drives within the same *virtual drive*. Although you can mix drives, the practice is strongly discouraged.

Broadcom offers a family of MegaRAID SATA+SAS RAID controllers that address the needs for both internal and external solutions. The 12Gb/s MegaRAID SATA+SAS RAID controllers are based on the Broadcom SAS technology and proven MegaRAID technology. As third-generation PCIe RAID controllers, these controllers address the growing demand for increased data throughput and scalability requirements across midrange and enterprise-class server platforms. The controllers provide the following features:

- 12Gb/s Serial Attached SCSI (SAS) performance
- 6Gb/s SATA III performance
- Eight-lane, 8 GT/s PCIe host interface

### 1.1.1 SAS/SATA Standards and Communication Protocols

MegaRAID SATA+SAS controllers support the ANSI *Serial Attached SCSI standard, version 3.0*. In addition, the controller supports the SATA III protocol defined by the *Serial ATA specification, version 3.0*. Supporting both SAS and the SATA interface, the SAS controller is a versatile controller that provides the backbone of both server and high-end workstation environments.

Each port on your MegaRAID SAS RAID controller supports SAS devices, SATA devices, or both, by using the following protocols:

- SAS Serial SCSI Protocol (SSP), which enables communication with other SAS devices
- SATA, which enables communication with other SATA devices
- Serial Management Protocol (SMP), which communicates topology management information directly with an attached SAS expander device
- Serial Tunneling Protocol (STP), which enables communication with SATA devices through an attached expander

## 1.1.2 Cache Backup Support Using CacheVault Flash Modules and CacheVault Power Modules

The following 12Gb/s MegaRAID SAS RAID controllers support the CacheVault Module Kit LSICVM02, which includes a CacheVault Flash Module (CVFM) 04 module, a CacheVault Power Module (CVPM) 02 module, a clip, and a cable:

- MegaRAID SAS 9361-4i RAID controller
- MegaRAID SAS 9361-8i RAID controller
- MegaRAID SAS 9361-24i RAID controller
- MegaRAID SAS 9362-8i RAID controller
- MegaRAID SAS 9380-4i4e RAID controller
- MegaRAID SAS 9380-8e RAID controller

The CVFM04 module is an Open NAND Flash Interface (ONFI) flash module that provides cache offload capability to protect cached data in case of host power loss or server failure. The CVPM02 module is a super-capacitor pack that provides power to back up your data in case of host power loss or server failure.

The CVFM04 module installs directly on the RAID connector, and connects by cable to a CVPM02 module that is attached to a remote mount board.

The following 12Gb/s MegaRAID SAS RAID controllers support data retention by using NAND flash memory down on the controller and power backup by a CVPM02 module on a remote mount board. The controller connects by cable to the remote CVPM02 module.

- MegaRAID SAS 9361-16i RAID controller
- MegaRAID SAS 9380-8i8e RAID controller

The MegaRAID SAS 9365-28i RAID controllers supports data retention by using NAND flash memory down on the controller and power backup by a CVPM05 module on a remote mount board. The controller connects by cable to the remote CVPM05 module.

**ATTENTION** You cannot hot-plug CVPM modules. Removing or inserting a CVPM module with the server powered on damages the board and the battery functionality. To attach or remove a CVPM module from a controller, you must fully power down the controller before you attach the module to, or remove the module from, its mating connector.

For more information about CVFM modules and CVPM modules, refer to the *Cache Backup Products for MegaRAID SAS+SATA RAID Controllers User Guide*. See [Section 1.8, Technical Support](#), for the link to the Broadcom Technical Support page for storage and board support.

## 1.2 General Description

The 12Gb/s MegaRAID SATA+SAS RAID controllers bring 12Gb/s Serial Attached SCSI and 6Gb/s SATA III performance to host adapter, workstation, and server designs. The following table shows which controllers are based on which devices.

**Table 1 12Gb/s MegaRAID SAS Controller and Devices**

12Gb/s MegaRAID SAS Controller	Device
MegaRAID SAS 9341-4i	SAS3004 PCIe-to-SAS/SATA
MegaRAID SAS 9341-8i	SAS3008 PCIe-to-SAS/SATA
MegaRAID SAS 9361-4i	SAS3108 PCIe RoC

**Table 1 12Gb/s MegaRAID SAS Controller and Devices (Continued)**

12Gb/s MegaRAID SAS Controller	Device
MegaRAID SAS 9361-8i	SAS3108 PCIe RoC
MegaRAID SAS 9380-4i4e	SAS3108 PCIe RoC
MegaRAID SAS 9380-8e	SAS3108 PCIe RoC
MegaRAID SAS 9361-16i	SAS3316 dual-core PCIe RoC
MegaRAID SAS 9380-8i8e	SAS3316 dual-core PCIe RoC
MegaRAID SAS 9361-24i	SAS3324 dual-core PCIe RoC
MegaRAID SAS 9365-28i	SAS3508 PCIe RoC device and SAS35x36 expander

The controllers support internal storage devices, external storage devices, or both, which allow you to use a system that supports enterprise-class SAS drives and desktop-class SATA III drives. Each 12Gb/s MegaRAID SATA+SAS RAID controller can connect to drives and can use expanders to connect to additional drives. Simplified cabling between devices is an additional benefit.

These devices are compliant with the Fusion-MPT™ architecture and provides a PCIe x8 interface. Each port on the MegaRAID SAS controllers supports SAS devices, SATA devices, or both, using SSP, SMP, STP, and SATA.

**NOTE** All of these RAID controllers provide an x8 PCIe 3.0 interface.

#### **Flash ROM and Serial EMPROM Characteristics**

The 12Gb/s MegaRAID SATA+SAS RAID controllers all support Flash ROM for boot code and firmware, and serial EEPROM for BIOS configuration storage. Each 12Gb/s MegaRAID SATA+SAS RAID controller ensures data integrity by intelligently validating the compatibility of the SAS domain.

## **1.3 12Gb/s MegaRAID SATA+SAS RAID Controllers – Detailed Descriptions**

The 12Gb/s MegaRAID SATA+SAS RAID controllers are described in detail in the following subsections.

### **1.3.1 MegaRAID SAS 9341-4i RAID Controller**

The 12Gb/s MegaRAID SAS 9341-4i board is a PCIe 3.0 low-profile SAS/SATA disk array controller. The controller supports four internal SAS/SATA ports through one SFF-8643 mini-SAS HD-4i internal connector.

### **1.3.2 MegaRAID SAS 9341-8i RAID Controller**

The 12Gb/s MegaRAID SAS 9341-8i board is a PCIe 3.0 low-profile SAS/SATA disk array controller. The controller supports eight internal SAS/SATA ports through two SFF-8643 mini-SAS HD-4i internal connectors.

### **1.3.3 MegaRAID SAS 9361-4i RAID Controller**

The 12Gb/s MegaRAID SAS 9361-4i board is a PCIe 3.0 low-profile SAS/SATA disk array controller. The controller supports four internal SAS/SATA ports through one SFF-8643 mini-SAS HD-4i internal connector.

### 1.3.4 MegaRAID SAS 9361-8i RAID Controller

The 12Gb/s MegaRAID SAS 9361-8i board is a PCIe 3.0 low-profile SAS/SATA disk array controller. The controller supports eight internal SAS/SATA ports through two SFF-8643 mini-SAS HD-4i internal connectors.

### 1.3.5 MegaRAID SAS 9361-16i RAID Controller

The 12Gb/s MegaRAID SAS 9361-16i board is a PCIe 3.0 low-profile SAS/SATA disk array controller. The controller supports 16 internal SAS/SATA ports through four SFF-8643 mini-SAS HD-4i internal connectors.

### 1.3.6 MegaRAID SAS 9361-24i RAID Controller

The 12Gb/s MegaRAID SAS 9361-24i board is a PCIe 3.0 low-profile SAS/SATA disk array controller. The controller supports 24 internal SAS/SATA ports through six SFF-8643 mini-SAS HD-4i internal connectors.

### 1.3.7 MegaRAID SAS 9380-4i4e RAID Controller

The 12Gb/s MegaRAID SAS 9380-4i4e board is a PCIe 3.0 low-profile SAS/SATA disk array controller. The controller supports four internal SAS/SATA ports through one SFF-8643 mini-SAS HD-4i internal connector and four external SAS/SATA ports through one SFF-8644 mini-SAS HD-4e external connector.

### 1.3.8 MegaRAID SAS 9380-8e RAID Controller

The 12Gb/s MegaRAID SAS 9380-8e board is a PCIe 3.0 low-profile SAS/SATA disk array controller. The controller supports eight external SAS/SATA ports through two SFF-8644 mini-SAS HD-4e external connectors.

### 1.3.9 MegaRAID SAS 9380-8i8e RAID Controller

The 12Gb/s MegaRAID SAS 9380-8i8e board is a PCIe 3.0 low-profile SAS/SATA disk array controller. The controller supports eight internal SAS/SATA ports through two SFF-8643 mini-SAS HD-4i internal connectors and eight external SAS/SATA ports through two SFF-8644 mini-SAS HD-4e external connectors.

### 1.3.10 MegaRAID SAS 9365-28i RAID Controller

The 12Gb/s MegaRAID SAS 9365-28i board is a PCIe 3.0 full-profile SAS/SATA disk array controller. The controller supports 28 internal SAS/SATA ports through through six SFF-8643 mini-SAS HD-4i internal connectors and one four-port SFF-8654 connector.

## 1.4 Configuration Scenarios

You can use the MegaRAID SAS RAID controllers in three main scenarios:

- **Low-end, internal SATA configuration:** In this configuration, use the RAID controller as a high-end SATA II or SATA III compatible controller that connects up to eight drives directly or through a port expander. This configuration is mostly for low-end or entry servers. An out-of-band I<sup>2</sup>C bus provides enclosure management. Side bands of both types of internal SAS connectors support the SFF-8485 (SGPIO) interface.



- **Midrange internal SAS configuration:** This configuration is similar to an internal SATA configuration, but with high-end SAS drives. This configuration is suitable for low-range to midrange servers.
- **High-end external SAS/SATA configuration:** This configuration is for external connectivity using SATA II drives, SATA III drives, SAS drives, or SATA and SAS drive combinations. External enclosure management is supported through inband, SCSI-enclosed storage. The configuration must support STP and SMP.

The following figure shows a direct-connect configuration. The Inter-IC (I<sup>2</sup>C) interface communicates with peripherals. The external memory bus provides an 8-bit/16-bit interface to connect peripheral devices, such as nonvolatile static random access memory (NVSRAM) and Flash ROM.

**Figure 1 SAS Direct-Connect Application Example**

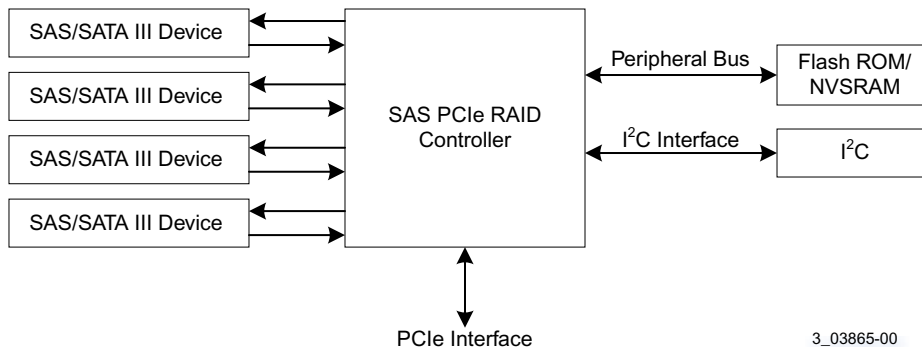

The following figure shows an example of a SAS RAID controller configured with a SASx12 expander that connects to SAS drives, SATA III drives, or both.

**Figure 2 SAS RAID Controller Configured with a SASx12 Expander Example**

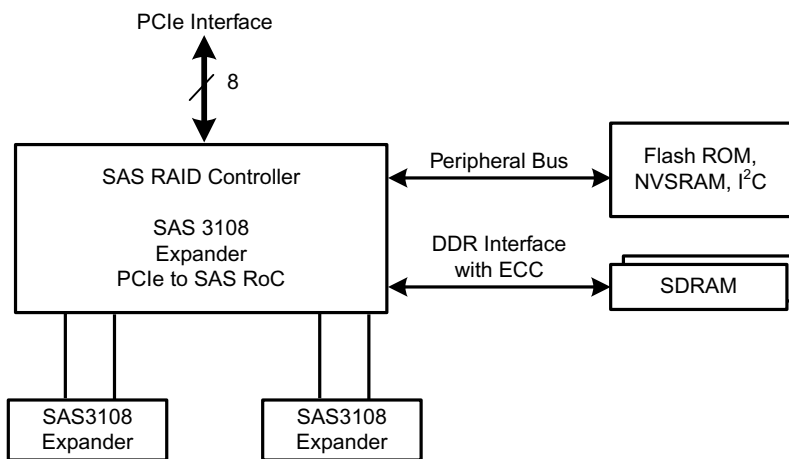

## 1.5 SAS Benefits

SAS is a serial, point-to-point, enterprise-level device interface that leverages the proven SCSI protocol set. SAS is a convergence of the advantages of SATA, SCSI, and Fibre Channel, and it is the mainstay of the enterprise and high-end workstation storage markets. SAS offers a higher bandwidth per pin than parallel SCSI, and it improves signal and data integrity.

SAS uses the proven SCSI command set to ensure reliable data transfers, while providing the connectivity and flexibility of point-to-point serial data transfers. The serial transmission of SCSI commands eliminates clock-skew challenges. SAS provides improved performance, simplified cabling, smaller connectors, lower pin count, and lower power requirements when compared to parallel SCSI.

SAS controllers leverage a common electrical and physical connection interface compatible with Serial ATA technology. The SAS protocols and the SATA III protocols use a thin, 7-wire connector instead of the 68-wire SCSI cable or 26-wire ATA cable. The SAS/SATA III connector and cable are easier to manipulate, allow connections to smaller devices, and do not inhibit airflow. The point-to-point SATA III architecture eliminates inherent difficulties created by the legacy ATA master-slave architecture, while maintaining compatibility with existing ATA firmware.

### 1.5.1 PCI Express Architecture

PCI Express (PCIe) is a local bus system designed to increase data transfers without slowing down the central processing unit (CPU). You can install MegaRAID PCIe RAID controllers in PCIe computer systems with a standard bracket type. With these controllers in your system, you can connect SAS devices and SATA devices over the PCIe bus.

**NOTE** Some PCIe slots support only PCIe graphics cards. RAID controllers installed in these PCIe slots do not function.

PCIe goes beyond the PCI specification in that it is intended as a unifying I/O architecture for various systems: desktops, workstations, mobile devices, servers, communications, and embedded devices.

### 1.5.2 Operating System Support

The 12Gb/s MegaRAID SATA+SAS RAID controllers support the following operating systems:

- Microsoft Windows Server 2016
- Microsoft Windows Server 2012
- Microsoft Windows 10
- VMware ESXi
- FreeBSD
- XenServer
- Red Hat Linux
- SuSE Linux Enterprise Server
- CentOS
- Oracle Enterprise Linux (OEL)
- Ubuntu Linux
- Debian Linux
- Fedora Linux

Refer to the *MegaRAID SAS Device Driver Installation User Guide* for driver information. To download the latest operating system drivers, go to <http://www.broadcom.com/support/download-search>.

The 12Gb/s MegaRAID SATA+SAS RAID controllers use Fusion-MPT architecture for all major operating systems, which results in thinner drivers and better performance.

## 1.6 Summary of 12Gb/s MegaRAID SATA+SAS RAID Controller Characteristics

This section summarizes the features and benefits offered by the 12Gb/s MegaRAID SATA+SAS RAID controllers, such as SAS features, SATA features, PCIe performance, integration, usability, and flexibility.

The 12Gb/s MegaRAID SATA+SAS RAID controllers have the following features:

- PCIe x8 lane width (with support for x16 connections)
- PCIe performance up to 8Gb/s per lane
- Support for 1-GB and 2-GB DDR3 at 1866 MHz with ONFI cache offload support
  - The MegaRAID SAS 9365-28i RAID controller supports 4-GB DDR4 at 2133 MHz
- One internal connector for the MegaRAID SAS 9341-4i RAID controller, the MegaRAID SAS 9361-4i RAID controller, and MegaRAID SAS 9380-4i4e RAID controller
- Two internal connectors for the MegaRAID SAS 9341-8i RAID controller, the MegaRAID SAS 9361-8i RAID controller, and the MegaRAID SAS 9380-8i8e RAID controller
- Four internal connectors for the MegaRAID SAS 9361-16i RAID controller
- Six internal connectors for the MegaRAID SAS 9361-24i RAID controller
- One external connector for the MegaRAID SAS 9380-4i4e RAID controller
- Two external connectors for the MegaRAID SAS 9380-8e RAID controller and the MegaRAID SAS 9380-8i8e RAID controller
- Seven internal connectors for the MegaRAID SAS 9365-28i RAID controller
- Support for RAID levels 0, 1, 5, 6, 10, 50, and 60
- Advanced array configuration and management utilities
- Support for global hot spares and dedicated hot spares
- Support for user-defined strip sizes: 64 KB, 128 KB, 256 KB, 512 KB, or 1024 KB

**NOTE** MegaRAID does not support strip sizes smaller than 64 KB. However, you can import virtual drives from legacy MegaRAID generations that use strip sizes smaller than 64 KB.

**NOTE** The MegaRAID SAS 9341-4i RAID controller and the MegaRAID SAS 9341-8i RAID controller support a stripe size of 64 KB only. The stripe size for these two controllers cannot be changed.

- Advanced array configuration and management utilities offer the following capabilities:
  - Online capacity expansion to add space to an existing drive or a new drive
  - Online RAID level migration
  - Drive migration
  - Drive roaming
  - No reboot necessary after expansion
  - Load balancing
  - Media scan
- User-specified rebuild rate (specify the percentage of system resources to use from 0 percent to 100 percent)
- NVSRAM of 32 KB to store RAID system configuration information; the MegaRAID SAS firmware is stored in flash ROM for easy upgrade.

## 1.6.1 SAS Features

The 12Gb/s MegaRAID SATA+SAS RAID controllers support the following SAS features:

- Four or eight fully independent phys, depending on the controller.
- 12Gb/s, 6Gb/s, and 3Gb/s SAS data transfers per phy.
- SMP to communicate topology-management information.
- SSP to enable communication with other SAS devices.
- STP to enable communication with SATA devices through an attached expander.

- Serial, point-to-point, enterprise-level storage interface.
- Simplified cabling between devices.
- They provide a scalable interface that supports up to 255 devices through the use of expanders.

**NOTE** The number of devices varies depending on the MegaRAID product. Check the Broadcom website, <http://www.broadcom.com>, for specific details about your product.

- Wide ports that consist of two, three, or four phys within a single quad port.
- Narrow ports consisting of a single phy.
- Data transfer by using SCSI information units.

## 1.6.2 SAS Array Limitations

This section describes the array limitations of the 12Gb/s MegaRAID SATA+SAS RAID controllers. These limitations include the number of drives supported per controller, the maximum number of drives per controller, and the maximum number of virtual drives allowed per controller.

The following table lists the array limitations for the 12Gb/s MegaRAID SATA+SAS RAID controllers.

**Table 2 12Gb/s MegaRAID SATA+SAS RAID Controllers Array Limitations**

Specification	SAS 9341-4i SAS 9341-8i	SAS 9361-4i SAS 9361-8i SAS 9361-16i SAS 9361-24i SAS9365-28i	SAS 9380-4i4e SAS 9360-8e SAS 9380-8i8e
Maximum virtual drives per controller	32	64	64
Maximum drive groups per controller	32	128	128
Maximum virtual drives per drive group	16	16	16
Maximum drives per drive group	32	32	32
Maximum drives per controller	64 (32 configurable drives)	128	240
Maximum hot spares per controller	32	128	240
Maximum spans per virtual drive	8	8	8
Maximum enclosures per port	2	16	16
Maximum enclosures per controller	2	32	32
Maximum drives supported per enclosure	64	64	64

These RAID controllers support 64-bit logical block addressing (LBA), which makes it possible to connect a large number of drives to the RAID controller, directly and through expanders. However, the actual number of drives that you can attach depends on the limits listed in the previous table rather than by actual RAID volume capacity.

## 1.6.3 SATA III Features

The following list describes the SATA III features of the RAID controllers:

- Supports SATA III data transfers of 6Gb/s.
- Supports STP data transfers of 6Gb/s and 3Gb/s.
- Provide a serial, point-to-point storage interface.
- Simplify cabling between devices.

- Eliminate the master-slave construction used in parallel ATA.
- Permit addressing of multiple SATA targets through an expander.
- Permit multiple initiators to address a single target (in a fail-over configuration) through an expander.
- Comply with *Serial ATA Specification, Version 3.0*.

#### 1.6.4 PCIe Performance

The following list describes the PCIe performance features of the RAID controllers:

- PCIe interface that does the following:
  - Supports a dedicated PCIe bus.
  - Supports x8 lane configuration.
  - Supports transfer rates of up to 8Gb/s per lane.
  - Complies with the *PCI Express Specification, Revision 3.0*.
- Unequaled performance through the Fusion-MPT architecture.
- High throughput and low CPU use to offload the host processor.

#### 1.6.5 Usability Features

The following list describes the usability features of the RAID controllers:

- Simplified cabling with point-to-point, serial architecture.
- Smaller, thinner cables that do not restrict airflow.
- Drive spin-up sequencing control.
- One LED signal for each phy to indicate link activity (this LED is a fault LED only for controllers with internal port connectors).
- I<sup>2</sup>C interface for enclosure management.
- Support for the internal SAS Sideband signal SFF-8485 (SGPIO) interface.

**NOTE** LED signals indicate an error condition or drive activity. MegaRAID controllers support different blink patterns for these LEDs, depending on the user configuration and storage enclosure. For information about the LED blink patterns, contact your storage enclosure manufacturer.

#### 1.6.6 Flexibility Features

These features increase the flexibility of the RAID controllers:

- Flash ROM interface and a NVSRAM interface.
- Flexible programming interface to tune I/O performance.
- Option to mix connections to SAS targets or SATA III targets.
- Leverage compatible connectors for SAS connections and SATA III connections.
- Group up to four phys in a single quad port to form a wide port.
- Program the World Wide Name.

## 1.6.7 Drive Roaming

Drive roaming occurs when the drives are changed to different ports on the same controller. When the drives are placed on different channels, the controller detects the RAID configuration from the configuration data on the drives.

Configuration data is saved in the NVSRAM on the RAID controller and on the drives attached to the controller. This action maintains the integrity of the data on each drive, even if the drives change their physical device ID.

**NOTE** If you move a drive that is being rebuilt, the rebuild operation restarts; it does not resume from the stopping point.

Follow these steps to use the drive roaming feature:

1. Turn off the power to the server and all drives, enclosures, and system components. Disconnect the power cords from the system.
2. Open the host system by following the instructions in the host system technical documentation.
3. Move the drives to different positions on the backplane to change the targets.
4. Determine the SAS target requirements.
5. Perform a safety check.
  - a. Make sure that the drives are inserted correctly.
  - b. Close the cabinet of the host system.
6. Reconnect the power cords to the system.
7. Turn on the power to the system.

The controller detects the RAID configuration from the configuration data on the drives.

## 1.6.8 Drive Migration

Drive migration is the transfer of a set of drives in an existing configuration from one controller to another. The drives must remain on the same channel and must be reinstalled in the same order as in the original configuration. Partial configurations, which include individual virtual drives, can be migrated. The controller to which you migrate the drives cannot have an existing configuration.

**NOTE** Drive roaming and drive migration cannot be supported at the same time.

Follow these steps to migrate drives:

1. Make sure that you clear the configuration on the system to which you migrate the drives to prevent a configuration data mismatch between the drives and the NVSRAM.

**NOTE** When you migrate drives, move only the drives that make up the virtual drive (not all of the drives in a drive group), so that you do not see an NVSRAM mismatch error (providing a configuration is on the destination controller). The NVSRAM mismatch error appears only if you move all of the drives to the other controller.

2. Turn off power to the server and all drives, enclosures, and system components. Disconnect the power cords from the systems.
3. Open the host system by following the instructions in the host system technical documentation.

4. Either remove the SAS cable connectors from the internal drives, or remove the shielded cables from the external drives that you want to migrate.
  - a. Make sure that pin 1 on the cable matches pin 1 on the connector.
  - b. Make sure that the SAS cables conform to all SAS specifications.
5. Remove the drives from the first system, and insert them into the drive bays on the second system.
6. Connect the SAS cables to the drives in the second system.
7. Determine the SAS target requirements.
8. Perform a safety check.
  - a. Make sure that all of the cables are attached correctly.
  - b. Make sure that the RAID controller is installed correctly.
  - c. Close the cabinet of the host system.
9. Reconnect the power cords to the system.
10. Turn on the power to the system.

The controller detects the RAID configuration from the configuration data on the drives.

## 1.7 Hardware Specifications

You can install the 12Gb/s MegaRAID SATA+SAS RAID controllers in a computer with a motherboard that has a PCIe slot. The following table describes the hardware configuration features for the 12Gb/s MegaRAID SATA+SAS RAID controllers.

**Table 3 12Gb/s MegaRAID SATA+SAS RAID Controller Features**

Specification	MegaRAID RAID Controllers	Supported Features
RAID levels	SAS 9341	0, 1, 5, 10, 50
	SAS 9361, SAS 9380, SAS 9365	0, 1, 5, 6, 10, 50, 60
Devices supported per port	SAS 9341	Up to 64 SAS devices or SATA III devices (such as drives and expanders)
	SAS 9361, SAS 9380, SAS 9365	Up to 255 SAS devices or SATA III devices (such as drives and expanders)
Number of ports	SAS 9341-4i and SAS 9361-4i	Four ports through one SFF-8643 mini-SAS HD-4i connector
	SAS 9341-8i and SAS 9361-8i	Eight ports through two SFF-8643 mini-SAS HD-4i connectors
	SAS 9361-16i	16 ports through four SFF-8643 mini-SAS HD-4i connectors
	SAS 9361-24i	24 ports through six SFF-8643 mini-SAS HD-4i connectors
	SAS 9380-4i4e	Four ports through one SFF-8643 mini-SAS HD-4i connector and four ports through one SFF-8644 mini-SAS HD-4e connector
	SAS 9380-8e	Eight ports through two SFF-8644 mini-SAS HD-4e connectors
	SAS 9380-8i8e	Eight ports through two SFF-8643 mini-SAS HD-4i connectors and eight ports through two SFF-8644 mini-SAS HD-4e connector
	SAS9365-28i	28 ports through seven SFF-8643 mini-SAS HD-4i connectors
Data transfer rate	All	Up to 12Gb/s per phy
Host Interface Bus	All	x8 PCIe 3.0
Cache function	All	Write-back, write-through, non-read-ahead, read-ahead, cache I/O, direct I/O
Multiple virtual drives per controller	SAS 9341	Up to 32
	SAS 9361, SAS 9380, SAS 9365	Up to 64

**Table 3 12Gb/s MegaRAID SATA+SAS RAID Controller Features (Continued)**

Specification	MegaRAID RAID Controllers	Supported Features
Online capacity expansion	All	Yes
Dedicated and global hot spares	All	Yes
Hot-swap devices	All	Supported
Non-drive devices	All	Supported
Mixed-capacity drives	All	Supported
Number of internal connectors	SAS 9361-16i	Four SFF-8643 mini-SAS HD-4i connectors
	SAS 9361-24i	Six SFF-8643 mini-SAS HD-4i connectors
	SAS 9341-4i, SAS 9361-4i, SAS 9380-4i4e	One SFF-8643 mini-SAS HD-4i connector
	SAS 9341-8i, SAS 9361-8i, SAS 9380-8i8e	Two SFF-8643 mini-SAS HD-4i connectors
	SAS9365-28i	Six SFF-8643 mini-SAS HD-4i internal connectors, one four-port SFF-8654 connector
Number of external connectors	SAS 9380-4i4e	One SFF-8644 mini-SAS HD-4e connector
	SAS 9380-8e, SAS 9380-8i8e	Two SFF-8644 mini-SAS HD-4e connectors
Hardware exclusive OR (XOR) assistance	All	Yes
Direct I/O	All	Yes
Architecture	All	Fusion-MPT

## 1.8 Technical Support

For assistance installing, configuring, or running your 12Gb/s MegaRAID SATA+SAS RAID controller, contact Broadcom Technical Support.

**Website:** <http://www.broadcom.com/support/>

**NOTE**

Record your controller serial number in a safe location in case you need to contact Broadcom.

**Phone Support:** <http://www.broadcom.com/support/call-us>

- 1-800-633-4545 (North America)
- 00-800-5745-6442 (International)
- 49 (0) 8941 352 0123 (Germany)

**NOTE**

The international toll-free number does not require country-specific access codes.

**Documents and Downloads:** <http://www.broadcom.com/support/download-search>



## Chapter 2: MegaRAID SAS Hardware Installation

### 2.1 Requirements

The following items are required to install a 12Gb/s MegaRAID SATA+SAS RAID controller:

- A MegaRAID SAS 93xx RAID controller
- A host system with an available x8 PCIe 3.0 slot

**NOTE** These controllers also work in PCIe first generation slots. The PCIe software is backward compatible with previous revisions of the PCI bus and the PCI-X bus.

- The *MegaRAID Universal Software Suite* CD, which contains the drivers and documentation
- The necessary internal cables, external cables, or both
- SAS drives or SATA drives

**NOTE** Make sure to use an uninterruptible power supply.

### 2.2 Quick Installation

Use the following steps to quickly install your 12Gb/s MegaRAID SATA+SAS RAID controller. These steps are for experienced computer users or installers. [Section 2.3, Detailed Installation](#), contains the steps for all other users to follow.

1. Turn off the power to the system and all drives, enclosures, and system components, and disconnect the PC power cord.
2. Open the host system cabinet by following the instructions in the host system technical documentation.
3. Check the jumper settings to make sure that they are in the desired position. The jumpers are set at the factory and you usually do not need to change them.

**NOTE** See [Chapter 3, 12Gb/s MegaRAID SAS RAID Controller Characteristics](#), for detailed information about the jumpers and the connectors.

4. Install the 12Gb/s MegaRAID SATA+SAS RAID controller in the server, and connect SAS devices or SATA devices to the controller. Make sure that the cables you use conform to all specifications.
5. Perform a safety check.
  - a. Make sure that all cables are attached correctly.
  - b. Make sure that the RAID controller is installed correctly.
  - c. Close the host system cabinet.
6. Reconnect the power cords to the system.
7. Turn on the power to any external drives.

Make sure that the power is turned on before the power is turned on to the host computer. If the computer is powered up before these drives, the drives might not be recognized.
8. Turn on the power to the system.

## 2.3 Detailed Installation

This section provides detailed instructions on how to install your 12Gb/s MegaRAID SATA+SAS RAID controller.

The figure in this section shows the installation of the MegaRAID SAS 9361-8i RAID controller in a PCIe slot. You can install other MegaRAID SAS RAID controllers in the same way.

1. Unpack your 12Gb/s MegaRAID SATA+SAS RAID controller.

Unpack and remove your controller. Inspect it for damage. If it appears damaged, or if any of the following items are missing, contact your Broadcom customer and technical support representative. The controller ships with the following items:

- A CD that contains an electronic version of this user guide, and other related documentation
- A license agreement
- Warranty information

2. Turn off the power to the system.

Turn off the power to the computer, and disconnect the AC power cord. Remove the computer cover. Refer to the system documentation for instructions. Before you install the controller, make sure that the computer is disconnected from the power and from any networks.

3. Review the RAID controller jumpers and connectors.

The jumpers are set at the factory, and you usually do not need to change them. See [Chapter 3, 12Gb/s MegaRAID SAS RAID Controller Characteristics](#), for diagrams of the 12Gb/s MegaRAID SATA+SAS RAID controllers that show their jumpers and connectors.

4. Install the RAID controller.

Select a PCIe slot, and align the controller's PCIe bus connector to the slot, as shown in the following figure. Press down gently, but firmly, to make sure that the card is seated correctly in the slot. Secure the bracket to the computer chassis with the bracket screw.

**ATTENTION** If your controller has a CVFM, do not press down on the module when you insert the controller.

**NOTE** This controller is a PCIe x8 card, and it can operate in x8 or x16 slots. However, some PCIe slots support only PCIe graphics cards; a controller installed in one of these slots will not function. Refer to the guide for your motherboard for information about the PCIe slot.

**Figure 3 Example of the MegaRAID SAS 9361-8i Controller Installation in a PCIe Slot**

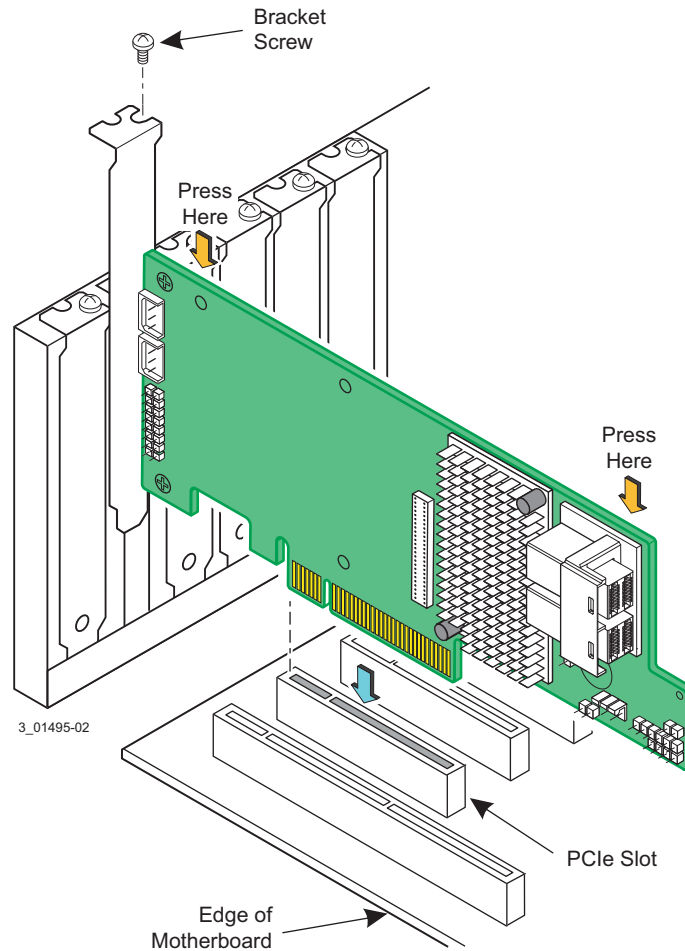

5. Configure and install the SAS devices, the SATA devices, or both in the host computer case. Refer to the documentation for the devices for any pre-installation configuration requirements.
6. Connect the RAID controller to the devices.  
Use SAS cables to connect SAS devices, SATA devices, or both to the 12Gb/s MegaRAID SATA+SAS RAID controller. See [Section 2.5, SAS Device Cables and Connectors](#), for SAS cable and connector information. See [Section 2.5.1, Connecting a RAID Controller with Internal Port Connectors to Internal Drives](#), for information about connecting the controller to the drives.  
The maximum cable length is 1 meter (39.37 in.). You can connect one device per SAS phy unless you use an expander.  
System throughput problems can occur if the SAS cables are not the correct type. To minimize the potential for problems, use the following guidelines:
  - Use cables no longer than 1 meter (39.37 in.). Use shorter cables, if possible.
  - Use cables that meet the SAS specification.
  - Route the SAS cables carefully.
7. Turn on the power to any external drives.  
Make sure that the power is turned on before the power is turned on to the host computer. If the computer is powered up before these drives, the drives might not be recognized.
8. Reinstall the computer cover, and reconnect the AC power cords.

9. Turn on the power to the host computer.

During boot, a BIOS message appears. The firmware takes several seconds to initialize. The configuration utility prompt times out after several seconds. The second portion of the BIOS message shows the 12Gb/s MegaRAID SATA+SAS RAID controller number, firmware version, and cache SDRAM size. The numbering of the controllers follows the PCI slot scanning order used by the host motherboard.

10. Run the WebBIOS configuration utility.

Run the WebBIOS configuration utility to configure the drive groups and the virtual drives. When the message `Press CTRL+H for WebBIOS` appears on the screen, immediately press **Ctrl+H** to run the utility.

11. Install the operating system driver.

MegaRAID SAS RAID controllers can operate under various operating systems. To operate under these operating systems, you must install the software drivers. The *MegaRAID Universal Software Suite* CD includes software drivers for the supported operating systems, along with documentation. You can view the supported operating systems and download the latest drivers for RAID controllers from the Broadcom website.

For information about installing the driver, refer to the *MegaRAID SAS Device Driver Installation User Guide* on the *MegaRAID Universal Software Suite* CD. Be sure to use the latest service packs provided by the operating system manufacturer and to review the `readme` file that accompanies the driver.

## 2.4 After Installing the RAID Controller

After you install the 12Gb/s MegaRAID SATA+SAS RAID controller, you must configure the controller and install the operating system driver. The *12Gb/s MegaRAID SAS Software User Guide* instructs you on the configuration options and how to set them on your 12Gb/s MegaRAID SATA+SAS RAID controller. The *MegaRAID SAS Device Driver Installation User Guide* provides detailed installation instructions for operating system drivers.

## 2.5 SAS Device Cables and Connectors

This section describes the cables and the connectors used on the MegaRAID SAS controllers and provides step-by-step instructions to connect SAS drives, SATA drives, or both to the MegaRAID SAS RAID controller. The SAS protocol and the SATA protocol use a thin, 7-wire connector instead of the 68-wire SCSI cable or the 40-wire ATA cable.

**NOTE** Use only straight SAS cables. Do not use crossover SAS cables.

The following figure shows the SATA III device plug connector that connects a SAS RAID controller with internal connectors to the host receptacle connector on a backplane. A SATA III connector consists of a signal connector and a power connector.

**Figure 4 SATA III Connector**

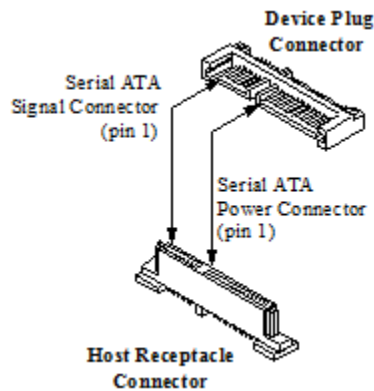

The following figure shows SAS connectors and SATA connectors on SAS drives and SATA drives, respectively. Cables connect internal connectors on the RAID controllers to connectors on SAS drives, SATA drives, or both. Both SAS drives and SATA drives can connect to SAS backplane receptacle connectors. The difference between the SAS connector and the SATA connector is the bridge between the SAS primary physical link and the power connector on the SAS controller, which the SATA connector does not have.

**NOTE** SAS backplane connectors accept SAS drives or SATA drives.  
SATA backplane connectors *cannot* accept SAS drives.

**Figure 5 SAS Plugs, SATA Plugs, and SAS Backplane Receptacle Connector**

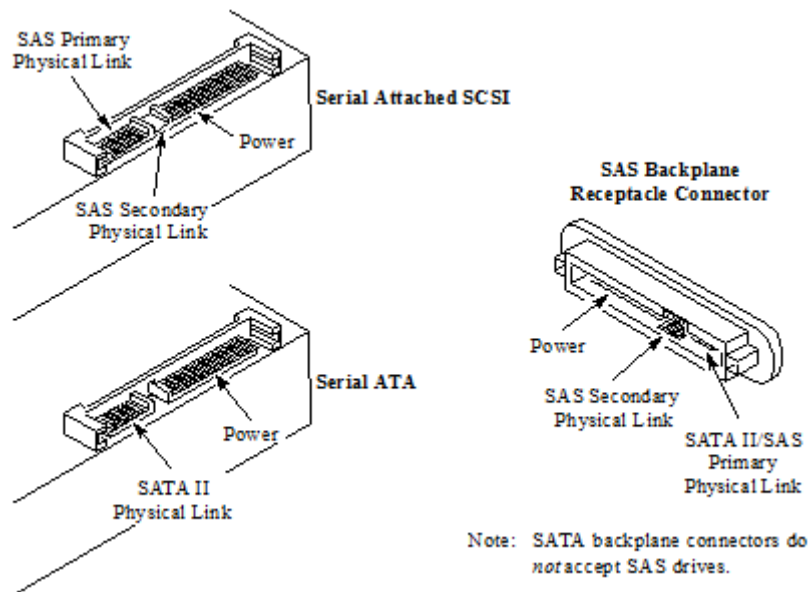

## 2.5.1 Connecting a RAID Controller with Internal Port Connectors to Internal Drives

This section provides step-by-step instructions to connect the SAS cable from the internal SAS port connectors on the RAID controller to internal SAS drives and SATA drives.

Follow these steps to connect your RAID controller with internal SAS port connectors directly to SAS drives or SATA drives.

**NOTE** The MegaRAID SAS 9361-8i RAID controller is shown as an example. You can connect the other MegaRAID SAS 93xx controllers with internal connectors in the same way.

1. Insert the SFF-8643 internal mini-SAS HD-4i connector into a SFF-8643 internal mini-SAS HD-4i connector on the MegaRAID SAS 9361-8i RAID controller, as shown in the following figure.
  2. Plug the HDD connector on the other end of the cable into the connector on the SAS drive or SATA drive.
  3. If you have another drive, connect it to another plug on the internal cable.
- You can connect other devices if the cable has more connectors.

**Figure 6 Connecting the MegaRAID SAS 9361-8i RAID Controller to a Drive**

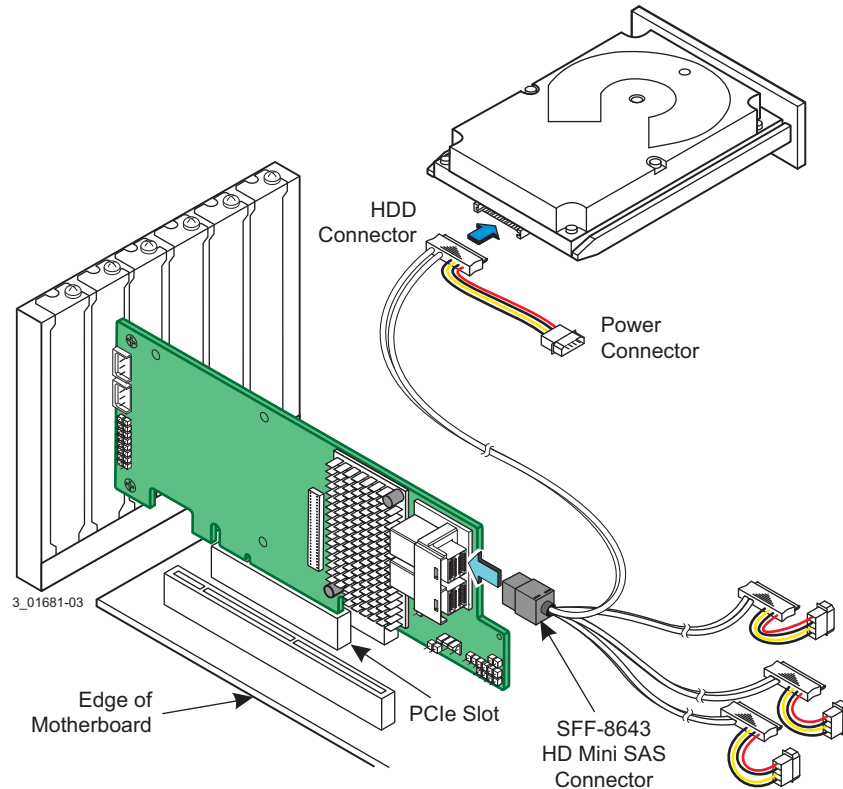

## 2.5.2 Connecting MegaRAID 16-Phy Controllers with Port Widths Greater than x1

The SAS 3316 chip has 16 SAS phys. The phys are managed in groups of eight by dedicated hardware in ascending phy order. One dedicated instance of the SAS phy management hardware manages PHY 0 to PHY 7, a separate instance of the SAS phy management hardware manages PHY 8 to PHY 15. These SAS phy management hardware instances, or SAS cores, cannot communicate with each other.

When you configure a wide-port connection using the MegaRAID high-port count controllers, the same SAS core must manage all phys connected to the wide port. If they are not managed by the same SAS core, unexpected controller and host behavior occurs. By default, the connectors are mapped as shown in [Figure 10](#) for the MegaRAID 9361-16i controller and [Figure 14](#) for the MegaRAID 9380-8i8e controller. For each board, the following table describes the mapping of board ports to SAS core instances.

**Table 4 Board Port-to-SAS Core Association**

Board	Ports 0–3	Ports 4–7	Ports 8–11	Ports 12–15
MegaRAID 9361-16i	SAS Core 1	SAS Core 1	SAS Core 0	SAS Core 0
MegaRAID 9380-8i8e	SAS Core 0	SAS Core 0	SAS Core 1	SAS Core 1

Ports 0–7 can be configured as eight separate ports or combined into one or more groups called wide ports (one x4, two x4s, one x8, and so on). Similarly, ports 8–15 can be configured as eight separate ports or combined into one or more wide ports. A single wide-port cannot combine individual ports or phys sourced by different SAS cores.

When you configure a boot device in a multi-path environment, the target must connect to one or more ports on the same SAS core with *AutoPortConfig* enabled. The boot device appears as a single device to the host system on the active path. The multi-path environment manages a different controller as the passive path.

When you configure data storage devices in a multi-path environment, the rule for creating wide ports applies, but multiple ports from different SAS cores can connect to the data storage devices. The multi-path environment manages data storage devices that the controller presents more than once.

### 2.5.3 Connecting a RAID Controller with External Port Connectors to a Drive Enclosure

This section provides step-by-step instructions to connect a MegaRAID SAS RAID controller with external SAS port connectors to a drive enclosure containing SAS drives, SATA drives, or a combination of both drive types.

Follow these steps to connect a cable from your controller to a drive enclosure.

**NOTE** The following figure shows the MegaRAID SAS 9380-8i8e RAID controller as an example. You can connect other 12Gb/s MegaRAID SAS controllers with external SAS port connectors in the same way.

1. Connect the mini-SAS HD 4-e cable plug connector on one end of the cable to an external port on the MegaRAID SAS 9380-8i8e RAID controller, as shown in the following figure.
2. Connect the other end of the cable to the external port on the drive enclosure.

**Figure 7 Connecting the MegaRAID SAS 9380-8i8e RAID Controller to a Drive Enclosure**

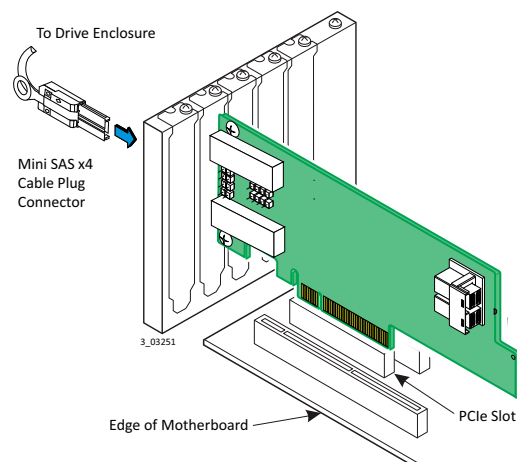

## Chapter 3: 12Gb/s MegaRAID SAS RAID Controller Characteristics

This chapter provides figures and connector information for each 12Gb/s MegaRAID SAS RAID controller.

### 3.1 MegaRAID SAS 9341 RAID Controllers

The MegaRAID SAS 9341-4i low-profile SATA+SAS RAID controller controls four internal SAS/SATA ports through one SFF-8643 internal mini-SAS HD-4i connector.

The MegaRAID SAS 9341-8i low-profile SATA+SAS RAID controller controls eight internal SAS/SATA ports through two SFF-8643 internal mini-SAS HD-4i connectors.

#### 3.1.1 MegaRAID SAS 9341 RAID Controllers – Board Layout, Jumper, and Connector Information

This subsection provides the board layout, and the connector and jumper information for the MegaRAID SAS 9341 RAID controllers. The following figure shows the jumpers and the connectors on the MegaRAID SAS 9341-8i controller.

The MegaRAID SAS 9341-4i RAID controller is the same as the MegaRAID SAS 9341-8i RAID controller, except that the MegaRAID SAS 9341-8i RAID controller provides an additional internal port connector, J1B.

**NOTE** Pin 1 on each header and connector is highlighted in red in this figure.

**Figure 8 MegaRAID SAS 9341-8i RAID Controller Card Layout**

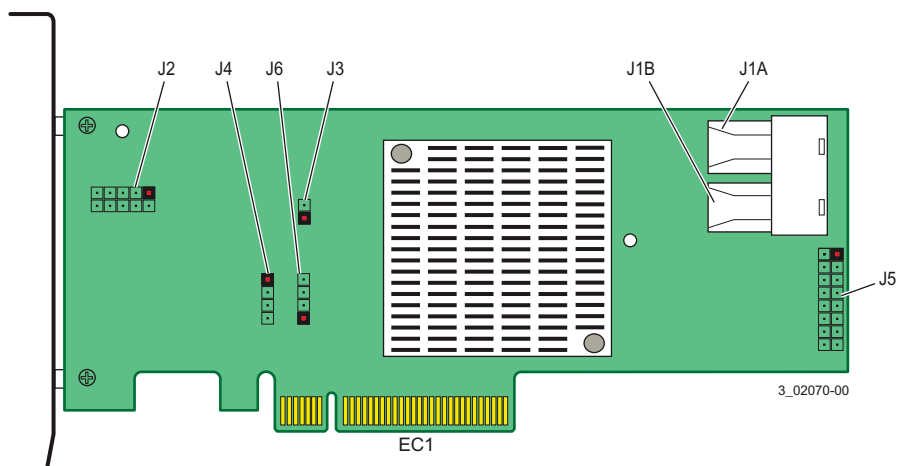

The following table describes the jumpers and the connectors on the MegaRAID SAS 9341 RAID controllers.



**Table 5 Jumpers and Connectors**

Jumper/ Connector	Type	Description
EC1	Standard edge card connector	The interface between the RAID controller and the host system. With the PCIe interface this connector provides power to the board and an I <sup>2</sup> C interface connected to the I <sup>2</sup> C bus for the Intelligent Platform Management Interface (IPMI).
J1A	x4 SAS Port 0 through Port 3 internal connector	Two SFF-8643 mini-SAS HD-4i internal connectors. Connects the controller by cable to SAS drives or SATA drives.
J1B	x4 SAS Port 4 through Port 7 internal connector	Two SFF-8643 mini-SAS HD-4i internal connectors. Connects the controller by cable to SAS drives or SATA drives.
J2	Complex programmable logic device (CPLD) header	10-pin header. Reserved for Broadcom use.
J3	Modular RAID Key header	2-pin connector. Reserved for Broadcom use.
J4	On-board Serial Universal Asynchronous Receiver/Transmitter (UART) connector	4-pin connector. Reserved for Broadcom use.
J5	RISCwatch header	16-pin header. Reserved for Broadcom use.
J6	Broadcom Test header	2-pin connector. Reserved for Broadcom use.

## 3.2 MegaRAID SAS 9361 RAID Controllers

The MegaRAID SAS 9361-4i low-profile SATA+SAS RAID controller controls four internal SAS/SATA ports through one SFF-8643 internal mini-SAS HD-4i connector.

The MegaRAID SAS 9361-8i low-profile SATA+SAS RAID controller controls eight internal SAS/SATA ports through two SFF-8643 internal mini-SAS HD-4i connectors.

The MegaRAID SAS 9361-16i low-profile SATA+SAS RAID controller controls 16 internal SAS/SATA ports through four SFF-8643 internal mini-SAS HD-4i connectors.

The MegaRAID SAS 9361-24i low-profile SATA+SAS RAID controller controls 24 internal SAS/SATA ports through six SFF-8643 internal mini-SAS HD-4i connectors.

### 3.2.1 MegaRAID SAS 9361-8i and MegaRAID SAS 9361-4i RAID Controller – Board Layout, Jumper, and Connector Information

This subsection provides the board layout, and the connector and jumper information for the MegaRAID SAS 9361-4i RAID controller and the MegaRAID SAS 9361-8i RAID controller.

The MegaRAID SAS 9361-4i RAID controller is the same as the MegaRAID SAS 9361-8i RAID controller except the J5A1 connector on the MegaRAID SAS 9361-4i RAID controller is a single internal port connector and the J5A1 connector on the MegaRAID SAS 9361-8i RAID controller is a dual internal port connector.

**NOTE** Pin 1 on the headers and connectors is highlighted in red in this figure.

The following figure shows the jumpers and the connectors on the MegaRAID SAS 9361-8i controller.

**Figure 9 MegaRAID SAS 9361-8i RAID Controller Card Layout**

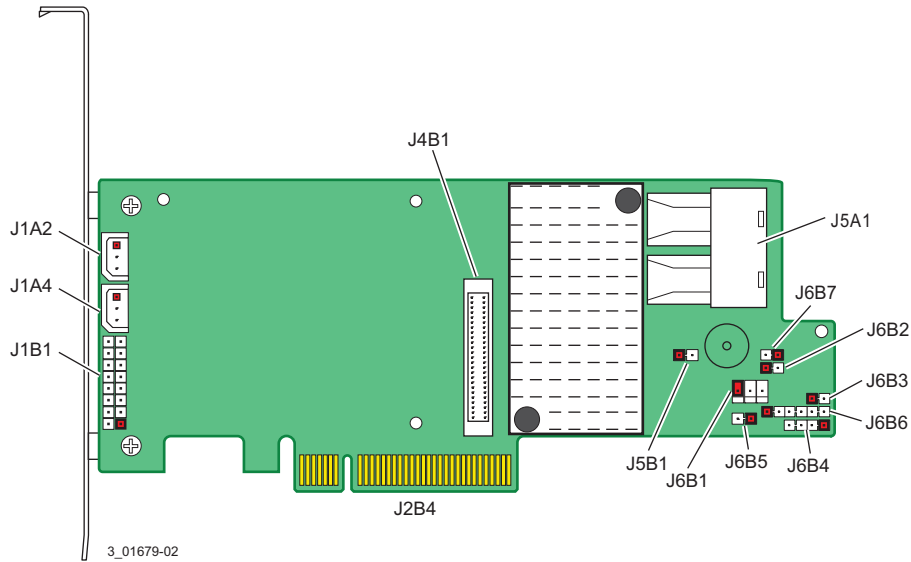

The following table describes the jumpers and the connectors on the MegaRAID SAS 9361-8i and MegaRAID SAS 9361-4i RAID controller.

**Table 6 Jumpers and Connectors**

Jumper/ Connector	Type	Description
J1A2	IPMI-style I <sup>2</sup> C connector for Ports 4 to 7	3-pin connector. Supports SCSI Enclosure Services (SES) over I <sup>2</sup> C through an internal I <sup>2</sup> C backplane cable.
J1A4	IPMI-style I <sup>2</sup> C connector for Ports 0 to 3	3-pin connector. Supports SES over I <sup>2</sup> C through an internal I <sup>2</sup> C backplane cable.

**Table 6 Jumpers and Connectors (Continued)**

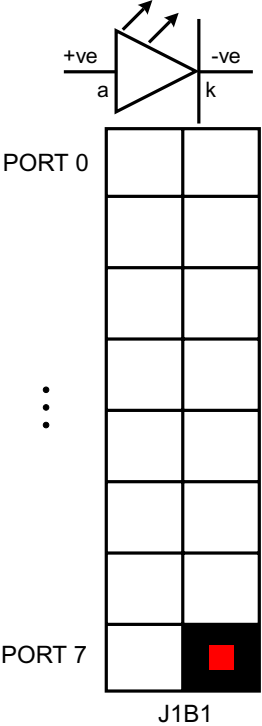
Jumper/ Connector	Type	Description
J1B1	Individual phy and drive fault indication header Ports 0 to 3 Ports 4 to 7  <p style="text-align: center;">J1B1 3_01788-00</p>	2x8-pin header. Connects to an LED that indicates whether a drive is in a fault condition. One LED exists per port. When lit, each LED indicates the corresponding drive has failed or is in the <i>Unconfigured-Bad</i> state. The LEDs function in a direct-attach configuration (no SAS expanders exist). Direct attach is defined as a maximum of one drive connected directly to each port. <b>NOTE</b> The J5A1 connector on the MegaRAID SAS 9361-4i RAID controller is a single internal port connector.
J2B4	Standard edge card connector	The interface between the RAID controller and the host system. Along with the PCIe interface, this connector provides power to the board and an I <sup>2</sup> C interface connected to the I <sup>2</sup> C bus for the IPMI.
J4B1	CacheVault Flash Module (ONFI) interface	70-pin connector. Connects the RAID controller to a flash module.
J5A1	Dual x4 SAS Port 0 through Port 7 internal connector	Two SFF-8643 mini-SAS HD-4i internal connectors. Connects the controller by cable to SAS drives or SATA drives.
J5B1	Broadcom Test header	2-pin connector. Reserved for Broadcom use.
J6B1	Advanced software options hardware key header	3-pin header. Enables support for selected advanced features, such as Recovery, CacheCade®, FastPath, and SafeStore™ disk encryption. Refer to the <i>MegaRAID Advanced Services Hardware Key Quick Installation Guide</i> for more information.
J6B2	Default Serial boot ROM (SBR) header	2-pin connector. Reserved for Broadcom use.

**Table 6 Jumpers and Connectors (Continued)**

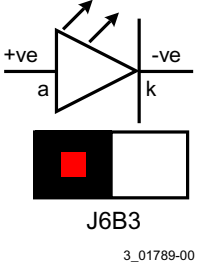
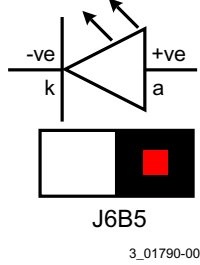
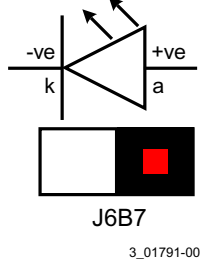
Jumper/ Connector	Type	Description
J6B3	Global hard disk drive (HDD) activity LED header   <p>J6B3 3_01789-00</p>	2-pin connector. Connects to an LED that indicates activity on the drives connected to the controller.
J6B4	On-board Serial UART connector	4-pin connector. Reserved for Broadcom use.
J6B5	Global drive fault LED header   <p>J6B5 3_01790-00</p>	2-pin connector. Connects to an LED that indicates whether a drive is in a fault condition
J6B6	CPLD header	6-pin connector. Reserved for Broadcom use.
J6B7	Cache write pending header   <p>J6B7 3_01791-00</p>	2-pin connector. Connector for an LED mounted on the system enclosure. The LED indicates that the data in the cache has yet to be written to the storage devices.

### 3.2.2 MegaRAID SAS 9361-16i RAID Controller – Board Layout, Jumper, and Connector Information

This subsection provides the board layout, and the connector and jumper information for the MegaRAID SAS 9361-16i RAID controller.

**NOTE** Pin 1 on each header and connector is highlighted in red in this figure.

The following figure shows the jumpers and the connectors on the controller.

**Figure 10 MegaRAID SAS 9361-16i RAID Controller Card Layout**

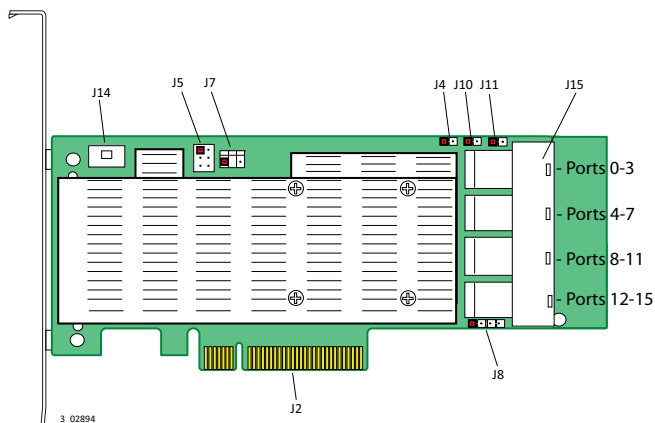

The following table describes the jumpers and the connectors on the MegaRAID SAS 9361-16i RAID controller.

**Table 7 Jumpers and Connectors**

Jumper/ Connector	Type	Description
J2	Standard edge card connector	The interface between the RAID controller and the host system. Along with the PCIe interface, this connector provides power to the board and an I <sup>2</sup> C interface connected to the I <sup>2</sup> C bus for the IPMI.
J4	Default SBR header	2-pin connector. Provides the ability to bypass loading the bootstrap configuration from the external SBR EEPROM device. Allows hardware to recover from a blank or corrupted SBR device. Reserved for Broadcom use.
J5	Complex programmable logic device (CPLD) header	6-pin connector. Reserved for Broadcom use.
J7	Advanced software options hardware key header	3-pin connector. Enables support for selected advanced features, such as Recovery, CacheCade, FastPath, and SafeStore disk encryption. Refer to the <i>MegaRAID Advanced Services Hardware Key Quick Installation Guide</i> for more information.
J8	On-board Serial UART connector	4-pin connector. Reserved for Broadcom use.
J10	Global HDD activity LED header	2-pin connector. Connects to an LED that indicates activity on the drives connected to the controller.

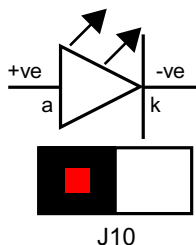

3\_03202

**Table 7 Jumpers and Connectors (Continued)**

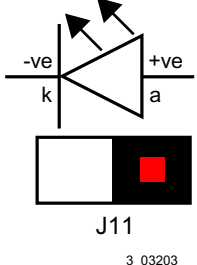
Jumper/Connector	Type	Description
J11	Global drive fault LED header 	2-pin connector. Connects to an LED that indicates whether a drive is in a fault condition.
J14	CacheVault Power Module interface	9-pin connector. Connects the RAID controller to a super-capacitor to provide power to back up data in case of host power loss or server failure.
J15	Quad x4 SAS Port 0 through Port 15 internal connector	Four SFF-8643 mini-SAS HD-4i internal connectors. Connects the controller by cable to SAS drives or SATA drives.

### 3.2.3 MegaRAID SAS 9361-24i RAID Controller – Board Layout, Jumper, and Connector Information

This subsection provides the board layout, and the connector and jumper information for the MegaRAID SAS 9361-24i RAID controller. The following figure shows the jumpers and the connectors on the controller.

**NOTE** Pin 1 on each header and connector is highlighted in red in this figure.

**Figure 11 MegaRAID SAS 9361-24i RAID Controller Card Layout**

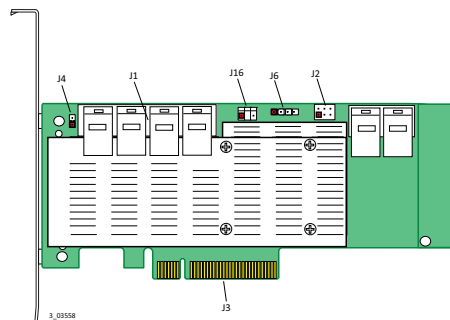

The following table describes the jumpers and the connectors on the MegaRAID SAS 9361-24i RAID controller.

**Table 8 Jumpers and Connectors**

Jumper/ Connector	Type	Description
J1	Quad x4 SAS Port 0 through Port 15 internal connector	Four SFF-8643 mini-SAS HD-4i internal connectors. Connects the controller by cable to SAS drives or SATA drives.
J2	CPLD header	6-pin header. Reserved for Broadcom use.
J3	Standard edge card connector	The interface between the RAID controller and the host system. With the PCIe interface this connector provides power to the board and an I <sup>2</sup> C interface connected to the I <sup>2</sup> C bus for the IPMI.
J4	Default SBR header	2-pin connector. Bypasses loading the bootstrap configuration from the external SBR EEPROM device. Allows the hardware to recover from a blank or corrupted SBR device. Reserved for Broadcom use.
J6	On-board Serial UART connector	4-pin connector. Reserved for Broadcom use.
J16	I <sup>2</sup> C	Supports SES over I <sup>2</sup> C through an internal I <sup>2</sup> C backplane cable.

### 3.3 MegaRAID SAS 9380 RAID Controllers

The MegaRAID SAS 9380-4i4e low-profile SATA+SAS RAID controller controls four internal SAS/SATA ports through one SFF-8643 internal mini-SAS HD-4i connector and four external SAS/SATA ports through one SFF-8644 mini-SAS HD-4e connector.

The MegaRAID SAS 9380-8e low-profile SATA+SAS RAID controller controls eight external SAS/SATA ports through two SFF-8644 mini-SAS HD-4e connectors.

The MegaRAID SAS 9380-8i8e low-profile SATA+SAS RAID controller controls eight internal SAS/SATA ports through two SFF-8643 internal mini-SAS HD-4i connectors and eight external SAS/SATA ports through two SFF-8644 mini-SAS HD-4e connectors.

#### 3.3.1 MegaRAID SAS 9380-4i4e RAID Controller – Board Layout, Jumper, and Connector Information

This subsection provides the board layout, and the connector and jumper information for the MegaRAID SAS 9380-4i4e RAID controller.

**NOTE** Pin 1 on the headers and connectors is highlighted in red in this figure.

The following figure shows the jumpers and the connectors on the controller.

**Figure 12 MegaRAID SAS 9380-4i4e RAID Controller Card Layout**

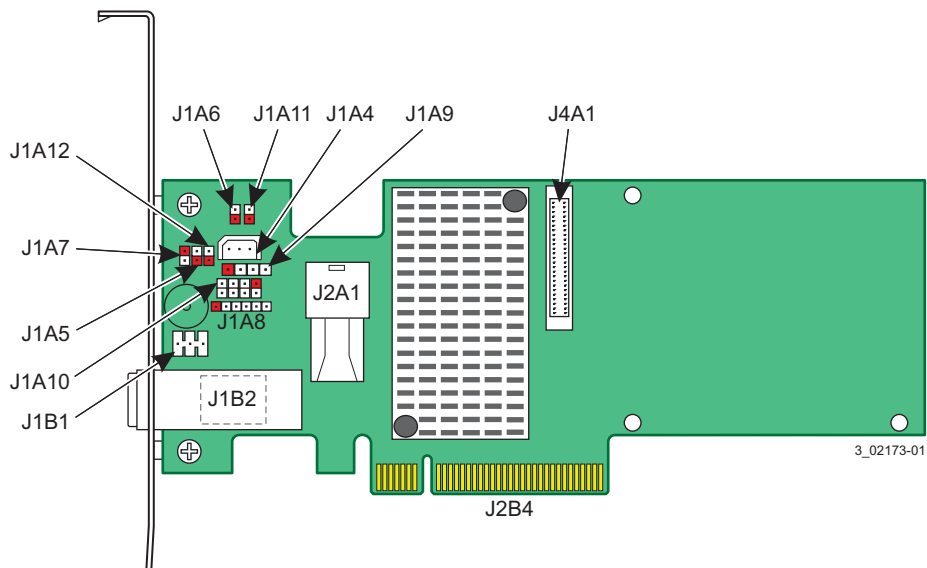

The following table describes the jumpers and the connectors on the MegaRAID SAS 9380-4i4e RAID controller.

**Table 9 Jumpers and Connectors**

Jumper/ Connector	Type	Description
J1A4	IPMI-style I <sup>2</sup> C connector for Ports 4 to 7	3-pin connector. Supports SES over I <sup>2</sup> C through an internal I <sup>2</sup> C backplane cable.
J1A5	Default SBR header	2-pin connector. Reserved for Broadcom use.
J1A6	Global drive fault LED header	2-pin connector. Connects to an LED that indicates activity on the drives that connect to the controller.
J1A7	Cache write pending header	2-pin connector. Connector for an LED mounted on the system enclosure. The LED indicates that the data in the cache has yet to be written to the storage devices.

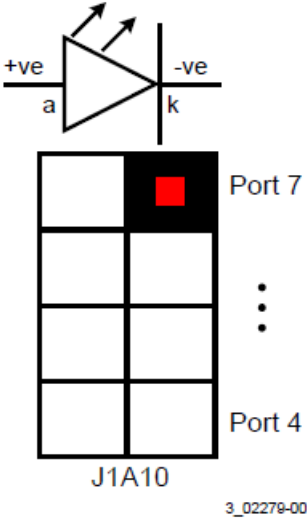
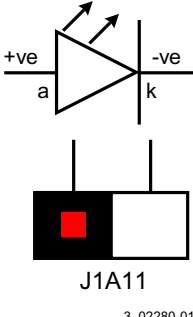

**Table 9 Jumpers and Connectors (Continued)**

Jumper/ Connector	Type	Description
J1A9	On-board Serial UART connector	4-pin connector. Reserved for Broadcom use.
J1A10	Individual phy and drive fault indication header Ports 4 to 7 	2x4-pin header Connects to an LED that indicates whether a drive is in a fault condition. One LED exists per port. When lit, each LED indicates the corresponding drive has failed or is in the <i>Unconfigured-Bad</i> state. The LEDs function in a direct-attach configuration (no SAS expanders exist). Direct attach is defined as a maximum of one drive connected directly to each port.
J1A11	Global HDD activity LED header 	2-pin connector. Connects to an LED that indicates activity on the drives connected to the controller.
J1A12	Broadcom Test header	2-pin connector. Reserved for Broadcom use.
J1B1	Advanced software options hardware key header	3-pin header. Enables support for selected advanced features, such as Recovery, CacheCade, FastPath, and SafeStore disk encryption. Refer to the <i>MegaRAID Advanced Services Hardware Key Quick Installation Guide</i> for more information.

**Table 9 Jumpers and Connectors (Continued)**

Jumper/Connector	Type	Description
J1B2	SAS Port 0 through Port 3 external connector	One SFF-8644 mini-SAS HD-4e external connector. Connects the controller by cable to an enclosure that contains SAS drives or SATA drives.
J2A1	SAS Port 4 through Port 7 internal connector	One SFF-8643 mini-SAS HD-4i internal connector. Connects the controller by cable to SAS drives or SATA drives.
J4A1	CacheVault Flash Module (ONFI) interface	80-pin connector. Connects the RAID controller to a flash module.

### 3.3.2 MegaRAID SAS 9380-8e RAID Controller – Board Layout, Jumper, and Connector Information

This subsection provides the board layout, and the connector and jumper information for the MegaRAID SAS 9380-8e RAID controller. The following figure shows the jumpers and the connectors on the controller.

**NOTE** Pin 1 on the headers and connectors is highlighted in red in this figure.

**Figure 13 MegaRAID SAS 9380-8e RAID Controller Card Layout**

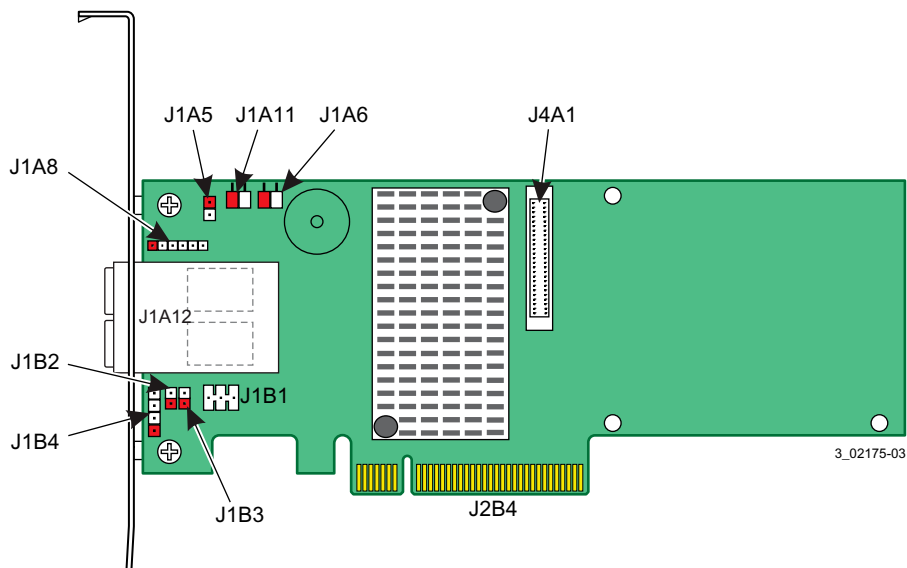

The following table describes the jumpers and the connectors on the MegaRAID SAS 9380-8e RAID controller.

**Table 10 Jumpers and Connectors**

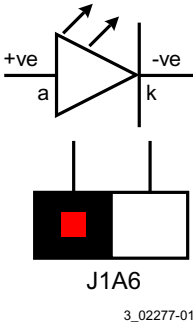
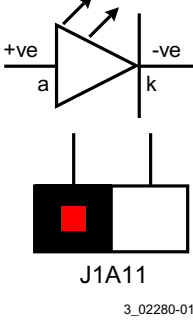
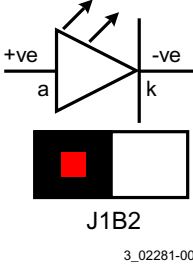
Jumper/Connector	Type	Description
J1A5	Default SBR header	2-pin connector. Reserved for Broadcom use.
J1A6	Global drive fault LED header  <p>J1A6 3_02277-01</p>	2-pin connector. Connects to an LED that indicates activity on the drives that connect to the controller.
J1A8	CPLD header	5-pin connector. Reserved for Broadcom use.
J1A11	Global HDD activity LED header  <p>J1A11 3_02280-01</p>	2-pin connector. Connects to an LED that indicates activity on the drives that connect to the controller.
J1A12	SAS Port 0 through Port 7 external connector	Two SFF-8644 mini-SAS HD-4e external connectors Connects the controller by cable to an enclosure that contains SAS drives or SATA drives.
J1B1	Advanced software options hardware key header	3-pin header. Enables support for selected advanced features, such as Recovery, CacheCade, FastPath, and SafeStore disk encryption. Refer to the <i>MegaRAID Advanced Services Hardware Key Quick Installation Guide</i> for more information.
J1B2	Cache write pending header  <p>J1B2 3_02281-00</p>	2-pin connector. Connector for an LED mounted on the system enclosure. The LED indicates that the data in the cache has yet to be written to the storage devices.
J1B3	Broadcom Test header	2-pin connector. Reserved for Broadcom use.

**Table 10 Jumpers and Connectors (Continued)**

Jumper/Connector	Type	Description
J1B4	On-board Serial UART connector	4-pin connector. Reserved for Broadcom use.
J2B4	Standard edge card connector	The interface between the RAID controller and the host system. With the PCIe interface this connector provides power to the board and an I <sup>2</sup> C interface connected to the I <sup>2</sup> C bus for the IPMI.
J4A1	CacheVault Flash Module (ONFI) interface	80-pin connector. Connects the RAID controller to a flash module.

### 3.3.3 MegaRAID SAS 9380-8i8e RAID Controller – Board Layout, Jumper, and Connector Information

This subsection provides the board layout, and the connector and jumper information for the MegaRAID SAS 9380-8i8e RAID controller. The following figure shows the jumpers and the connectors on the controller.

**NOTE** Pin 1 on the headers and connectors is highlighted in red in this figure.

**Figure 14 MegaRAID SAS 9380-8i8e RAID Controller Card Layout**

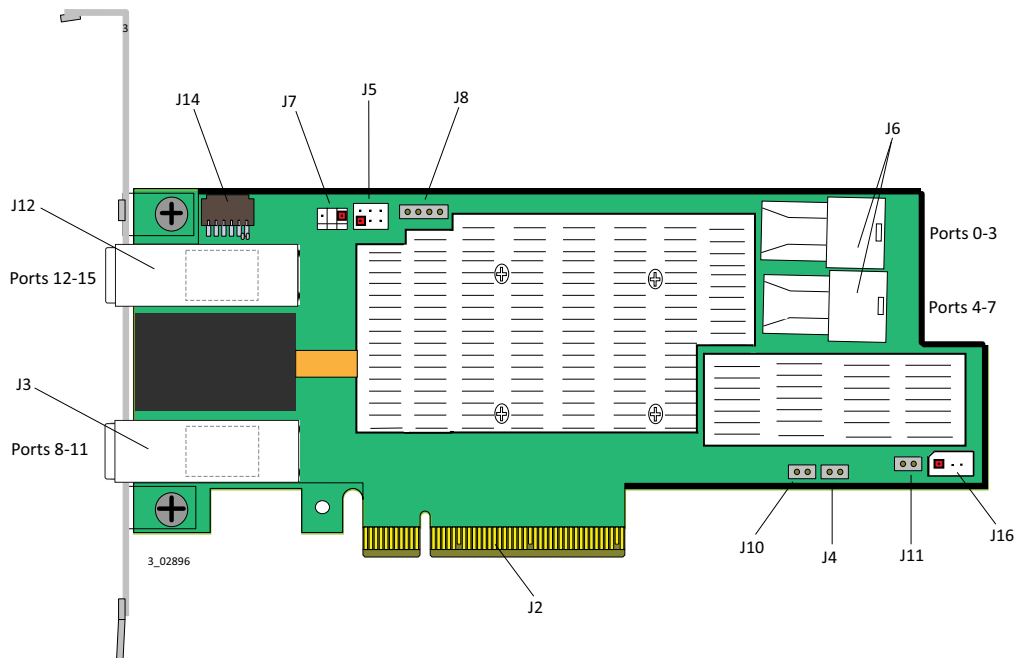

The following table describes the jumpers and the connectors on the MegaRAID SAS 9380-8i8e RAID controller.

**Table 11 Jumpers and Connectors**

Jumper/ Connector	Type	Description
J2	Standard edge card connector	The interface between the RAID controller and the host system. With the PCIe interface this connector provides power to the board and an I <sup>2</sup> C interface connected to the I <sup>2</sup> C bus for the IPMI.
J3	SAS Port 8 through Port 11 external connector	One SFF-8644 mini-SAS HD-4e external connector. Connects the controller by cable to an enclosure that contains SAS drives or SATA drives.
J4	Default SBR header	2-pin connector. Reserved for Broadcom use.
J5	CPLD header	6-pin header. Reserved for Broadcom use.
J6	SAS Port 0 through Port 7 internal connector	SFF-8643 mini-SAS HD-x2 4i internal connector. Connects the controller by cable to SAS drives or SATA drives.
J7	Advanced software options hardware key header	2-pin header (middle pin not populated). Enables support for selected advanced features, such as Recovery, CacheCade, FastPath, and SafeStore disk encryption. Refer to the <i>MegaRAID Advanced Services Hardware Key Quick Installation Guide</i> for more information.
J8	On-board Serial UART connector	4-pin connector. Reserved for Broadcom use.
J10	Global HDD activity LED header	2-pin connector. Connects to an LED that indicates activity on the drives that connect to the controller.
J11	Global drive fault LED header	2-pin connector. Connects to an LED that indicates activity on the drives that connect to the controller.
J12	SAS Port 12 through Port 15 external connector	One SFF-8644 mini-SAS HD-4e external connector. Connects the controller by cable to an enclosure that contains SAS drives or SATA drives.
J14	CacheVault Power Module interface	9-pin connector. Connects the RAID controller to a super-capacitor to provide power to back up your data in case of host power loss or server failure.
J16	IPMI-style I <sup>2</sup> C connector for Ports 0 to 3	3-pin connector. Supports SES over I <sup>2</sup> C through an internal I <sup>2</sup> C backplane cable.
JT12	Standard edge card connector	The interface between the RAID controller and the host system. Along with the PCIe interface, this connector provides power to the board and an I <sup>2</sup> C interface connected to the I <sup>2</sup> C bus for the IPMI.

### 3.4 MegaRAID SAS 9365-28i RAID Controller

The MegaRAID SAS 9365-28i full-profile SATA+SAS RAID controller controls 28 internal SAS/SATA ports through seven SFF-8643 internal mini-SAS HD-4i connectors.

### 3.4.1 MegaRAID 9365-28i RAID Controller – Board Layout, Jumper, and Connector Information

This subsection provides the board layout, and the connector and jumper information for the MegaRAID SAS 9365-28i RAID controller. The following figure shows the jumpers and the connectors on the controller.

**NOTE** Pin 1 on the headers and connectors is highlighted in red in this figure.

**Figure 15 MegaRAID SAS 9365-28i RAID Controller Card Layout**

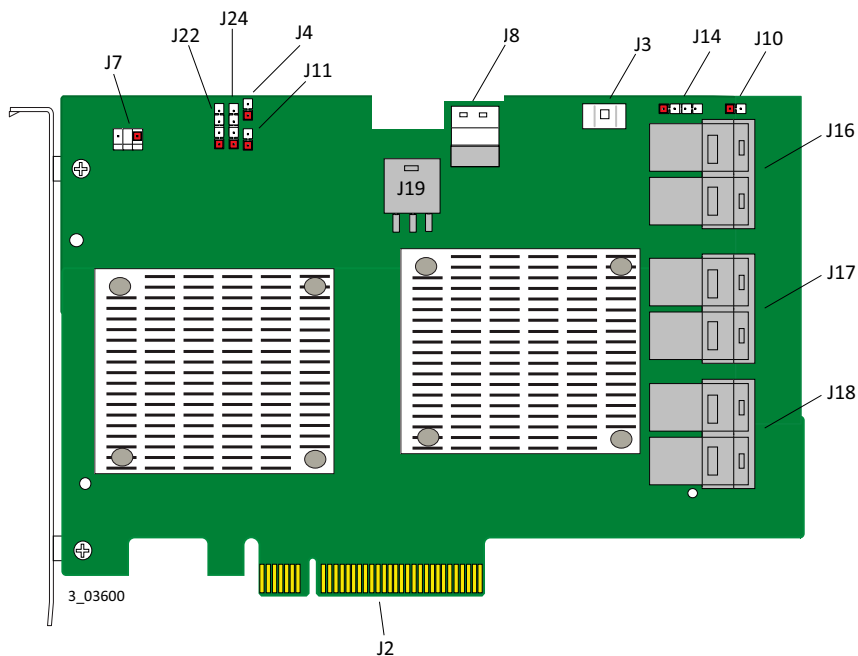

The following table describes the jumpers and the connectors on the MegaRAID 9365-28i controller.

**Table 12 Jumpers and Connectors**

Jumper/ Connector	Type	Description
J2	Standard edge card connector	The interface between the storage adapter and the host system. With the PCIe interface this connector provides power to the board and an I <sup>2</sup> C interface connected to the I <sup>2</sup> C bus for the IPMI.
J3	CacheVault Power Module interface	9-pin connector Connects the storage adapter to a CacheVault power module.
J4	Power-on sense connector	2-pin connector. Enable or disable the SBL.
J7	RAID Premium Key Feature header	2-pin connector. Reserved for Broadcom use.
J8	Quad x4 SAS Port 24 through Port 27 internal connector	One SFF-8654 SlimLine connector. Connects the controller by cable to SAS drives or SATA drives.
J10	Global HDD activity LED header	2-pin connector. Connects to an LED that indicates activity on the drives connected to the controller.

**Table 12 Jumpers and Connectors (Continued)**

Jumper/Connector	Type	Description
J11	Global LED	2-pin connector. Global drive fault LED.
J14	On-board Serial UART connector	4-pin connector. Reserved for Broadcom use.
J16	Quad x4 SAS Port 0 through Port 7 internal connector	Two SFF-8643 mini-SAS HD-4i internal connectors. Connects the controller by cable to SAS drives or SATA drives.
J17	Quad x4 SAS Port 8 through Port 15 internal connector	Two SFF-8643 mini-SAS HD-4i internal connectors. Connects the controller by cable to SAS drives or SATA drives.
J18	Quad x4 SAS Port 16 through Port 23 internal connector	Two SFF-8643 mini-SAS HD-4i internal connectors Connects the controller by cable to SAS drives or SATA drives.
J19	Auxiliary power connector	4-pin connector. Connects the controller to an auxiliary power source.
J22	MDIO connector	4-pin connector. Reserved for Broadcom use.
J24	SBD UART connector	4-pin connector. Reserved for Broadcom use.

## 3.5 Technical Specifications

The design and implementation of the 12Gb/s MegaRAID SATA+SAS RAID controllers minimize electromagnetic emissions, susceptibility to radio frequency energy, and the effects of electrostatic discharge. The 12Gb/s MegaRAID SATA+SAS RAID controllers show the following marks, certifications, and compliances:

- CE mark
- RCM mark
- FCC Self-Certification logo
- Canadian Compliance Statement
- Korean MIC
- Taiwan BSMI
- Japan VCCI
- CISPR Class B
- CSA C22.2 No. 60950-1, UL 60950-1 First Edition-listed accessory, UL file number E257743

### 3.5.1 RAID Controller Specifications

The following table lists the specifications for the 12Gb/s MegaRAID SATA+SAS RAID controller.

**Table 13 MegaRAID Controller Specifications**

Specification	MegaRAID RAID Controllers	Specification Information
Processor/SAS controller	SAS 9341-4i, SAS 9341-8i	SAS3008 PCIe-to-SAS/SATA controller
	SAS 9361-24i	SAS3324 dual-core PCIe RoC device
	SAS 9361-4i, SAS 9361-8i, SAS 9380	SAS3108 PCIe RoC device
	SAS 9361-16i, SAS 9380-8i8e	SAS3316 dual-core PCIe RoC device
	SAS 9365-28i	SAS3516 dual-core PCIe RoC device and SAS35x36 expander
Model number	SAS 9341-4i	25461
	SAS 9341-8i	25461
	SAS 9361-4i	25420
	SAS 9361-8i	25420
	SAS 9361-16i	25708
	SAS 9361-24i	50022
	SAS 9380-4i4e	25190
	SAS 9380-8e	25528
	SAS 9380-8i8e	25716
	SAS 9365-28i	50028
Operating voltage	All	+3.3 V, +12 V
Card size	SAS 9341	Low-profile PCIe adapter card size (68.90 mm × 152.35 mm)
	SAS 9361-16i, SAS 9361-24i	Low-profile PCIe adapter card size (68.90 mm × 135 mm)
	SAS 9361-4i, SAS 9361-8i, SAS 9380-4i4e, SAS 9380-8e, SAS 9380-8i8e	Low-profile PCIe adapter card size (68.90 mm × 167.65 mm)
	SAS 9365-28i	Full-profile PCIe adapter card size (155.65 mm × 111.15 mm)
Array interface to the host	All	PCIe Rev. 3.0
PCI Express bus data transfer rate	All	<ul style="list-style-type: none"> <li>■ Up to 8GB/s per lane</li> <li>■ x8 lane width</li> </ul>
Serial port	All	4-pin RS232-compatible connector (for manufacturing use only)
SAS bus speed	All	12Gb/s
SAS ports	All	SAS connectors with four SAS ports each

## 3.6 Array Performance Features

The following table shows the array performance features for the 12Gb/s MegaRAID SATA+SAS RAID controllers.

**Table 14 Array Performance Features**

Specification	Feature
PCI Express host data transfer rate	8GB/s per lane
Drive data transfer rate	12GB/s per lane
Maximum scatter/gather I/O	80 elements
Maximum size of I/O requests	6.4 MB in 64-KB strips



**Table 14 Array Performance Features (Continued)**

Specification	Feature
Maximum queue tags per drive	As many as the drive can accept
Strip sizes	8 KB, 16 KB, 32 KB, 64 KB, 128 KB, 256 KB, 512 KB, or 1 MB
Maximum number of concurrent commands	255

## 3.7 Fault Tolerance Features

The following table lists the fault tolerance features for the 12Gb/s MegaRAID SATA+SAS RAID controllers.

**Table 15 Fault Tolerance Features**

Specification	Feature
Support for SMART <sup>a</sup>	Yes
Drive failure detection	Automatic
Drive rebuild using hot spares	Automatic
Parity generation and checking	Yes

- a. The Self Monitoring Analysis and Reporting Technology (SMART) detects up to 70 percent of all predictable drive failures. In addition, SMART monitors the internal performance of all motors, heads, and drive electronics.

## 3.8 Electrical Characteristics

This subsection provides the power supply requirements for the 12Gb/s MegaRAID SATA+SAS RAID controllers.

### 3.8.1 Operating and Nonoperating Conditions

The following table lists the operating (thermal and atmospheric) conditions and nonoperating (such as storage and transit) environment for the 12 Gb/s MegaRAID SAS RAID controllers. Also adhere to the following guidelines:

- The minimum airflow, measured as linear feet per minute (LFPM), must be met to avoid operating the controller's processor above the maximum junction temperature.
- For controllers with a CVPM, keep the ambient temperature as low as possible to maximize the module's lifespan.

**Table 16 Operating and Nonoperating Conditions**

MegaRAID RAID Controller	Operating Conditions			Nonoperating Environment	
	Relative Humidity Range (noncondensing)	Minimum LFPM	Temperature Range <sup>a</sup>	Relative Humidity Range (noncondensing)	Temperature Range
SAS 9341-4i	5% to 90%	75	0°C to +55°C	5% to 90%	-45°C to +105°C
SAS 9341-8i	5% to 90%	75	0°C to +55°C	5% to 90%	-45°C to +105°C
SAS 9361-4i	20% to 80%	200	10°C to +55°C	5% to 90%	-40°C to +70°C
SAS 9361-8i	20% to 80%	200	10°C to +55°C	5% to 90%	-40°C to +70°C
SAS 9361-16i	20% to 80%	300	10°C to +55°C	20% to 95%	-40°C to +70°C
SAS 9361-24i	20% to 80%	300	10°C to +50°C	20% to 95%	-40°C to +70°C

**Table 16 Operating and Nonoperating Conditions (Continued)**

MegaRAID RAID Controller	Operating Conditions			Nonoperating Environment	
	Relative Humidity Range (noncondensing)	Minimum LFPM	Temperature Range <sup>a</sup>	Relative Humidity Range (noncondensing)	Temperature Range
SAS 9380-4i4e	20% to 80%	200	10°C to +55°C	5% to 90%	-40°C to +70°C
SAS 9380-8e	20% to 80%	200	10°C to +55°C	5% to 90%	-40°C to +70°C
SAS 9380-8i8e	20% to 80%	200	10°C to +55°C	5% to 90%	-40°C to +70°C
SAS 9365-28i	20% to 80%	250	0°C to +45°C	5% to 95%	-40°C to +105°C

a. For controllers with a CVPM, the this range applies with or without the CVFM attached.

### 3.8.2 MegaRAID SAS 9341-4i RAID Controller and MegaRAID SAS 9341-8i RAID Controller Power Supply Requirements

All power is supplied to the MegaRAID SAS 9341 RAID controllers through the PCIe 12V rail. Onboard switching regulator circuitry operating from the 12V rail provides the necessary voltages.

The supply voltages are 12V ± 8 percent (from PCI edge connector only). The following table lists the power supply for the MegaRAID SAS 9341 RAID controllers at peak mode and at normal power mode.

**Table 17 Power Supply for MegaRAID SAS 9341 RAID Controllers**

Power Mode	Power Mode Description	DC Power (Watts)
Peak (on-max)	Maximum	19.04W
On-Normal/Typical	Typical	13W

### 3.8.3 MegaRAID SAS 9361-4i RAID Controller and MegaRAID SAS 9361-8i RAID Controller Power Supply Requirements

All power is supplied to the MegaRAID SAS 9361-4i RAID controller and the MegaRAID SAS 9361-8i RAID controller through the PCIe 3.3V rails and the 12V rail. Onboard switching regulator circuitry operating from the 3.3V rails and the 12V rail provides the necessary voltages. The following states determine the typical current consumption of the controller:

- State 1: While sitting idle at the DOS prompt
- State 2: During a drive stress test
- State 3: Power on the controller with a deeply depleted CVPM attached

The supply voltages are 12V ± 8 percent (from PCI edge connector only) and 3.3V ± 9 percent (from PCI edge connector only). The following table lists the power supply for the RAID controllers for these three states at the different voltages.

**Table 18 Power Supply for MegaRAID SAS 9361-4i and SAS 9361-8i RAID Controllers**

PCI Edge Connector	State 1	State 2	State 3
3.3V supply	793 mA	793 mA	789 mA
+12V supply	915 mA	1090 mA	1.457 A
3.3V auxiliary supply	1 mA	1 mA	1 mA
Total Power	13.95W	16.15W	20.062W

### 3.8.4 MegaRAID SAS 9361-16i RAID Controller Power Supply Requirements

All power is supplied to the MegaRAID SAS 9361-16i RAID controller through the PCIe 3.3V rails and the 12V rail. Onboard switching regulator circuitry operating from the 3.3V rails and the 12V rail provides the necessary voltages. The following states determine the typical current consumption of the controller:

- State 1: While sitting idle at the DOS prompt
- State 2: During a drive stress test

The supply voltages are  $12V \pm 8$  percent (from PCI edge connector only) and  $3.3V \pm 9$  percent (from PCI edge connector only). The following table lists the power supply for the RAID controllers for these two states at the different voltages.

**Table 19 Power Supply for the MegaRAID SAS 9361-16i RAID Controller**

PCI Edge Connector	State 1	State 2
3.3V supply	75 mA	106 mA
+12V supply	1403 mA	1938 mA
3.3V auxiliary supply	24 mA	24 mA
Total Power	16.29W	23.17W

During the transparent learn cycle, the CacheVault power module consumes up to an additional 6W. The power for the learn cycle is supplied from the PCIe 3.3V rail.

### 3.8.5 MegaRAID SAS 9361-24i RAID Controller Power Supply Requirements

All power is supplied to the MegaRAID SAS 9361-24i RAID controller through the PCIe 3.3V rails and the 12V rail. Onboard switching regulator circuitry operating from the 3.3V rails and the 12V rail provides the necessary voltages. The following states determine the typical current consumption of the controller:

- State 1: While sitting idle at the DOS prompt
- State 2: During a drive stress test

The supply voltages are  $12V \pm 8$  percent (from PCI edge connector only) and  $3.3V \pm 9$  percent (from PCI edge connector only). The following table lists the power supply for the RAID controllers for these two states at the different voltages.

**Table 20 Power Supply for the MegaRAID SAS 9361-24i RAID Controller**

PCI Edge Connector	State 1	State 2
3.3V supply	52 mA	52 mA
+12V supply	1980 mA	2380 mA
3.3V auxiliary supply	9 mA	9 mA
Total Power	23.96W	28.76W

During the transparent learn cycle, the CacheVault power module consumes up to an additional 6W. The power for the learn cycle is supplied from the PCIe 3.3V rail.

### 3.8.6 MegaRAID SAS 9380-4i4e RAID Controller Power Supply Requirements

All power is supplied to the MegaRAID SAS 9380-4i4e RAID controller through the PCIe 3.3V rails and the 12V rail. Onboard switching regulator circuitry operating from the 3.3V rails and the 12V rail provides the necessary voltages. The following states determine the typical current consumption of the controller:

- State 1: While sitting idle at the DOS prompt
- State 2: During a drive stress test
- State 3: Power on the controller with a deeply depleted CVPM module attached

The supply voltages are 12V  $\pm$  8 percent (from PCI edge connector only) and 3.3V  $\pm$  9 percent (from PCI edge connector only). The following table lists the power supply for the RAID controllers for these three states at the different voltages.

**Table 21 Power Supply for the MegaRAID SAS 9380-4i4e RAID Controller**

PCI Edge Connector	State 1	State 2	State 3
3.3V supply	727 mA	1030 mA	1280 mA
+12V supply	1050 mA	1410 mA	1640 mA
3.3V auxiliary supply	10 mA	10 mA	10 mA
Total Power	15.212W	20.574W	24.153W

### 3.8.7 MegaRAID SAS 9380-8e RAID Controller Power Supply Requirements

All power is supplied to the MegaRAID SAS 9380-8e RAID controller through the PCIe 3.3V rails and the 12V rail. Onboard switching regulator circuitry operating from the 3.3V rails and the 12V rail provides the necessary voltages. The following states determine the typical current consumption of the controller:

- State 1: While sitting idle at the DOS prompt
- State 2: During a drive stress test
- State 3: Power on the controller with a deeply depleted CVPM module attached

The supply voltages are 12V  $\pm$  8 percent (from PCI edge connector only) and 3.3V  $\pm$  9 percent (from PCI edge connector only). The following table lists the power supply for the RAID controller for these three states at the different voltages.

**Table 22 Power Supply for MegaRAID SAS 9380-8e RAID Controllers**

PCI Edge Connector	State 1	State 2	State 3
3.3V supply	800 mA	880 mA	800 mA
+12V supply	1000 mA	1220 mA	1520 mA
3.3V auxiliary supply	20 mA	20 mA	10 mA
Total Power	14.95W	17.91W	21.266W

### 3.8.8 MegaRAID SAS 9380-8i8e RAID Controller Power Supply Requirements

All power is supplied to the MegaRAID SAS 9380-8i8e RAID controller through the PCIe 3.3V rails and the 12V rail. Onboard switching regulator circuitry operating from the 3.3V rails and the 12V rail provides the necessary voltages. The following states determine the typical current consumption of the controller:

- State 1: While sitting idle at the DOS prompt
- State 2: During a drive stress test

The supply voltages are  $12V \pm 8$  percent (from PCI edge connector only) and  $3.3V \pm 9$  percent (from PCI edge connector only). The following table lists the power supply for the RAID controllers for these two states at the different voltages.

**Table 23 Power Supply for the MegaRAID SAS 9380-8i8e RAID Controller**

PCI Edge Connector	State 1	State 2
3.3V supply	75 mA	66 mA
+12V supply	1403 mA	1960 mA
3.3V auxiliary supply	2 mA	2 mA
Total Power	16.22W	23.74W

During the transparent learn cycle, the CacheVault power module consumes up to an additional 6W. The power for the learn cycle is supplied from the PCIe 3.3V rail.

### 3.8.9 MegaRAID 9365-28i SAS RAID Controller Power Supply Requirements

All power is supplied to the MegaRAID SAS 9365-28i RAID controller through the PCIe 3.3V rails and the 12V rail. Onboard switching regulator circuitry operating from the 3.3V rails and the 12V rail provides the necessary voltages. The following states determine the typical current consumption of the controller:

- State 1: While sitting idle at the DOS prompt
- State 2: During a drive stress test

The supply voltages are  $12V \pm 8$  percent (from PCI edge connector only) and  $3.3V \pm 9$  percent (from PCI edge connector only). The following table lists the power supply for the RAID controllers for these two states at the different voltages.

**Table 24 Power Supply for the MegaRAID 9365-28i SAS RAID Controller**

PCI Edge Connector	State 1	State 2
3.3V supply	0.20W	0.20W
+12V supply	20.25W	21.25W
3.3V auxiliary supply	0.08W	0.08W
Total Power	20.53W	21.53W

During the transparent learn cycle, the CacheVault Power Module consumes up to an additional 6W. The power for the learn cycle is supplied from the PCIe 3.3V rail.

## 3.9 Safety Characteristics

All 12Gb/s MegaRAID SATA+SAS RAID controllers meet or exceed the requirements of UL flammability rating 94 V0. Each bare board is also marked with the supplier name or trademark, type, and UL flammability rating. For the boards installed in a PCI Express bus slot, all voltages are lower than the SELV 42.4V limit.

## 3.10 Accessory Instructions

For use only with compatible UL-listed servers that have installation instructions that detail user installation of board and accessories.

## Appendix A: Glossary

### B

#### **BIOS**

Acronym for basic input/output system. Software that provides basic read/write capability. Usually kept as firmware (ROM-based). The system BIOS on the motherboard of a computer boots and controls the system. The BIOS on your host adapter acts as an extension of the system BIOS.

### C

#### **configuration**

Refers to the way a computer is set up, the combined hardware components (computer, monitor, keyboard, and peripheral devices) that make up a computer system, or the software settings that allow the hardware components to communicate with each other.

#### **CVFM**

Acronym for CacheVault Flash module.

### D

#### **device driver**

A program that permits a microprocessor (through the operating system) to direct the operation of a peripheral device.

#### **domain validation**

A software procedure in which a host queries a device to determine its ability to communicate at the negotiated data rate.

#### **drive group**

A group of physical drives that combines the storage space on the drives into a single segment of storage space. A hot spare drive does not actively participate in a drive group.

### E

#### **EEPROM**

Acronym for electronically erasable programmable read-only memory. It is a memory chip that typically stores configuration information, as it provides stable storage for long periods without electricity and can be reprogrammed. See NVSRAM.

#### **external SAS device**

A SAS device installed outside the computer cabinet. These devices are connected using specific types of shielded cables.

### F

#### **Fusion-MPT architecture**

An acronym for Fusion-Message Passing Technology architecture. Fusion-MPT architecture consists of several main elements: Fusion-MPT firmware, the Fibre Channel and SCSI hardware, and the operating system-level drivers that support these architectures. Fusion-MPT architecture offers a single binary, operating system driver that supports both Fibre Channel and SCSI devices.

## **H**

### **host**

The computer system in which a RAID controller is installed. It uses the RAID controller to transfer information to and from devices attached to the SCSI bus.

### **host adapter board**

A circuit board or integrated circuit that provides a device connection to the computer system.

### **hot spare**

An idle, powered on, standby drive that is ready for immediate use in case of drive failure. A hot spare does not contain any user data. A hot spare can be dedicated to a single redundant array or it can be part of the global hot-spare pool for all arrays managed by the controller.

When a drive fails, the controller firmware automatically replaces and rebuilds the data from the failed drive to the hot spare. Data can be rebuilt only from virtual drives with redundancy (RAID levels 1, 5, 6, 10, 50, and 60; not RAID level 0), and the hot spare must have sufficient capacity.

## **I**

### **internal SAS device**

A SAS device installed inside the computer cabinet. These devices are connected by using a shielded cable.

## **M**

### **main memory**

The part of computer memory that is directly accessible by the CPU (usually synonymous with RAM).

## **N**

### **NVSRAM**

Acronym for nonvolatile static random access memory. An EEPROM chip that stores configuration information. See EEPROM.

## **P**

### **PCI**

Acronym for Peripheral Component Interconnect. A high-performance, local bus specification that allows the connection of devices directly to computer memory. The PCI Local Bus allows transparent upgrades from 32-bit data path at 33 MHz to 64-bit data path at 33 MHz, and from 32-bit data path at 66 MHz to 64-bit data path at 66 MHz.

### **PCI Express**

Acronym for Peripheral Component Interconnect Express. A high-performance, local bus specification that permits the connection of devices directly to computer memory. PCI Express is a two-way, serial connection that transfers data on two pairs of point-to-point data lines. PCI Express goes beyond the PCI specification in that it is intended as a unifying I/O architecture for various systems: desktops, workstations, mobile, server, communications, and embedded devices.

### **peripheral devices**

A piece of hardware (such as a video monitor, drive, printer, or CD-ROM) used with a computer and under the control of the computer. SCSI peripherals are controlled through a MegaRAID SAS RAID controller (host adapter).

## **PHY**

The interface required to transmit and receive data packets transferred across the serial bus.

Each PHY can form one side of the physical link in a connection with a PHY on a different SATA device. The physical link contains four wires that form two differential signal pairs. One differential pair transmits signals, while the other differential pair receives signals. Both differential pairs operate simultaneously and allow concurrent data transmission in both the receive and the transmit directions.

## R

### RAID

Acronym for Redundant Array of Independent Disks (originally Redundant Array of Inexpensive Disks). An array (group) of multiple independent drives managed together to yield higher reliability, performance, or both exceeding that of a single drive. The RAID array appears to the controller as a single storage unit. I/O is expedited because several drives can be accessed simultaneously. Redundant RAID levels (RAID levels 1, 5, 6, 10, 50, and 60) provide data protection.

### RAID levels

A set of techniques applied to drive groups to deliver higher data availability, performance characteristics, or both to host environments. Each virtual drive must have a RAID level assigned to it.

## S

### SAS

Acronym for Serial Attached SCSI. A serial, point-to-point, enterprise-level device interface that leverages the proven SCSI protocol set. The SAS interface provides improved performance, simplified cabling, smaller connections, lower pin count, and lower power requirements when compared to parallel SCSI. SAS controllers leverage a common electrical and physical connection interface that is compatible with Serial ATA.

The SAS controllers support the ANSI Serial Attached SCSI Standard, Version 2.0. In addition, the controller supports the Serial ATA III (SATA III) protocol defined by the *Serial ATA Specification, Version 3.0*. Supporting both the SAS interface and the SATA III interface, the SAS controller is a versatile controller that provides the backbone of both server and high-end workstation environments. Each port on the SAS RAID controller supports SAS devices, SATA devices, or both.

### SAS device

Any device that conforms to the SAS standard and is attached to the SAS bus by a SAS cable. This includes SAS RAID controllers (host adapters) and SAS peripherals.

### SATA

Acronym for Serial Advanced Technology Attachment. A physical storage interface standard, SATA is a serial link that provides point-to-point connections between devices. The thinner serial cables allow for better airflow within the system and permit smaller chassis designs.

### SBL

Acronym for serial bootstrap loader.

### SMP

Acronym for Serial Management Protocol. SMP communicates topology management information directly with an attached SAS expander device. Each PHY on the controller can function as an SMP initiator.

### SSP

Acronym for Serial SCSI Protocol. SSP enables communication with other SAS devices. Each PHY on the SAS controller can function as an SSP initiator or an SSP target.

### STP

Acronym for Serial Tunneling Protocol. STP enables communication with a SATA device through an attached expander. Each PHY on the SAS controller can function as an STP initiator.



**strip**

The portion of a stripe that resides on a single drive.

**stripe size**

The total drive space consumed by a stripe not including a parity drive. For example, if a stripe contains 64 KB of drive space and has 16 KB of data residing on each drive, the stripe size is 64 KB and the strip size is 16 KB.

A larger stripe size produces improved read performance, especially if most of the reads are sequential. For mostly random reads, select a smaller stripe size.

**striping**

Drive striping writes data across two or more drives. Each stripe spans two or more drives but consumes only a portion of each drive. Each drive, therefore, may have several stripes. The amount of space consumed by a stripe is the same on each drive that is included in the stripe. The portion of a stripe that resides on a single drive is a strip, also known as a stripe element. Striping by itself does not provide data redundancy; striping in combination with parity provides data redundancy.

**strip size**

The drive space consumed by a strip. For example, if a stripe contains 64 KB of drive space and has 16 KB of data residing on each drive, the stripe size is 64 KB and the strip size is 16 KB. The stripe depth is four (four drives in the stripe). You can specify strip sizes of 8 KB, 16 KB, 32 KB, 64 KB, 128 KB, 256 KB, 512 KB, or 1 MB.

## Revision History

### Version 1.7, October 31, 2017

The following document change was made.

- Changed the MegaRAID SAS 9365-28i RAID controller LFPM value in [Table 16, Operating and Nonoperating Conditions](#).

### Version 1.6, October 20, 2017

The following document changes were made.

- Added the MegaRAID SAS 9365-28i RAID controller.
- Removed the email support option from [Section 1.8, Technical Support](#).
- Moved content from the 12Gb/s MegaRAID SAS RAID Controller Characteristics section into [Section 1.2, General Description](#), and removed the 12Gb/s MegaRAID SAS RAID Controller Characteristics section.
- Updated [Section 1.5.2, Operating System Support](#).
- Combined operating condition and nonoperating condition information, and removed individual subsections in [Electrical Characteristics](#).
- Editorial updates.

### Version 1.5, June 14, 2017

The following document change was made.

- Added [Section 3.10, Accessory Instructions](#).

### Version 1.4, May 18, 2017

The following document changes were made.

- Added the MegaRAID SAS 9361-24i RAID controller.
- Updated the SAS array limitations for the new controllers in [Table 2](#) in [Section 1.6.2, SAS Array Limitations](#).
- Added [Section 2.5.2, Connecting MegaRAID 16-Phy Controllers with Port Widths Greater than x1](#).
- Updated [Section 1.8, Technical Support](#).

### Version 1.3, May 11, 2016

The following document changes were made.

- Added the MegaRAID SAS 9361-16i RAID controller and the MegaRAID SAS 9380-8i8e RAID controller.
- Updated the SAS array limitations for the new controllers in [Table 2](#) in [Section 1.6.2, SAS Array Limitations](#).

- Added [Section 2.5.2, Connecting MegaRAID 16-Phy Controllers with Port Widths Greater than x1](#).
- Updated [Section 1.8, Technical Support](#).

## **54027-00, Rev. C, February 2015**

The following document changes were made.

- Updated various artwork.
- Added the maximum drive count for enclosures to [Table 2](#) in [Section 1.6.2, SAS Array Limitations](#).

## **54027-00, Rev. B, April 2014**

The following document changes were made.

- Added the MegaRAID SAS 9380-4i4e RAID controller and the MegaRAID SAS 9380-8e RAID controller.

## **54027-00, Rev. A, October 2013**

Initial document release.

